

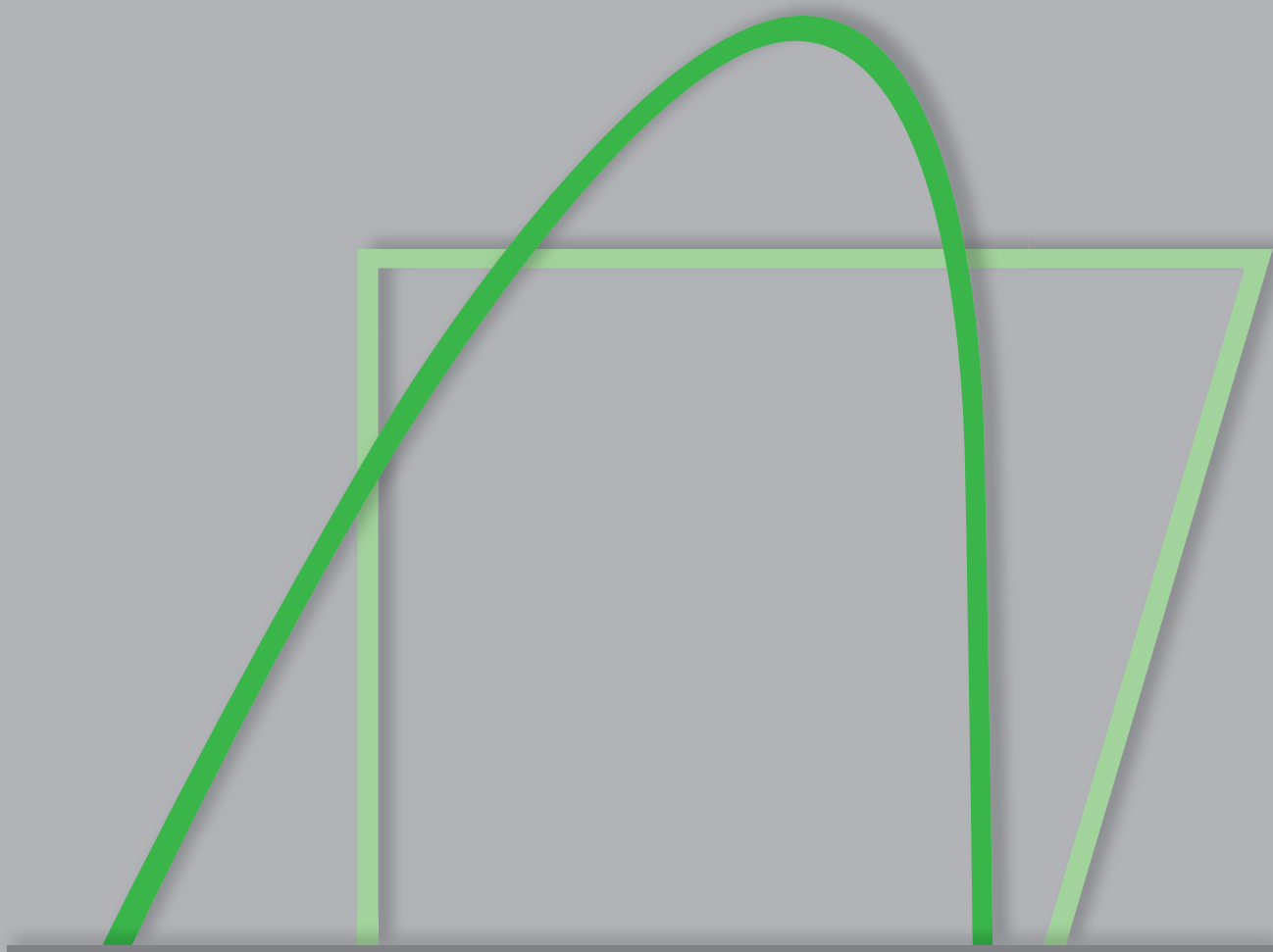

THE HEART OF FRESHNESS

REFRIGERANT REPORT 16



R407C

CO₂

R717

-40 °C

R290

R404A

40 °C

R134a

Page	Contents	Revisions/supplements vs. 15 th edition
3	General aspects on refrigerant developments	
3	Introduction	
4	Alternative refrigerants (overview)	
6	Environmental aspects	
6	Global Warming and TEWI factor	
7	Eco-Efficiency	
8	HCFC refrigerants	
8	R22 as transitional refrigerant	
9	Chlorine free (HFC) refrigerants	
9	R134a as a substitute for R12 and R22 ■ Lubricants for HFCs	
11	Alternatives to R134a	
11	R152a – an alternative to R134a (?)	
11	“Low GWP” refrigerant HFO-1234yf	
13	Refrigerant blends	
15	Service blends as substitutes for R502	
16	Service blends as substitutes for R12 (R500)	
17	Chlorine free R502 and R22 alternatives (blends)	
17	R404A and R507A as substitutes for R502 and R22	
18	R407A, R407B and R407F as substitutes for R502 and R22	
19	R422A as substitute for R502 and R22	
20	Chlorine free R22 alternatives (blends)	
20	R407C as substitute for R22	
21	R410A as substitute for R22	
22	R417A, R417B, R422D and R438A as substitutes for R22	
22	R427A as substitute for R22	
23	HFO/HFC blends as HFC alternatives	
24	Halogen free refrigerants	
24	NH ₃ (Ammonia) as alternative refrigerant	
25	R723 (NH ₃ /DME) as an alternative to NH ₃	
26	R290 (Propane) as substitute for R502 and R22	
28	Propylene (R1270) as an alternative to Propane	
29	CO ₂ as an alternative refrigerant and secondary fluid	
33	Special applications	
36	Refrigerant properties	
38	Application ranges ■ Lubricants	

Introduction

Stratospheric ozone depletion as well as atmospheric greenhouse effect due to refrigerant emissions have led to drastic changes in the refrigeration and air conditioning technology since the beginning of the 90s.

This is especially true for the area of commercial refrigeration and A/C plants with their wide range of applications. Until a few years ago the main refrigerants used for these systems were ozone depleting types, namely R12, R22 and R502; for special applications R114, R12B1, R13B1, R13 and R503 were used.

With the exception of R22 the use of these chemicals is not allowed any more in industrialised countries. In the European Union, however, there is a current early phase-out for R22 as well which shall be realised step by step (see page 8 for explanations).

The main reason for this early ban of R22 contrary to the international agreement is the ozone depletion potential although it is only small.

Since 2010, phase-out regulations got effective in other countries as well, in the USA for instance.

Due to this situation enormous consequences result for the whole refrigeration and air conditioning trade. BITZER therefore committed itself to taking a leading role in the research and development of environmentally benign system designs.

Although the chlorine free HFC refrigerants R134a, R404A, R507A, R407C, R410A as well as NH₃ and various hydrocarbons have already become established, there are still further tasks to perform, especially with respect to the global warming impact. The aim is to significantly reduce direct emissions caused by refrigerant loss, and indirect emissions through highly efficient plants.

Therefore a close co-operation exists with scientific institutions, the refrigeration and oil industries, component manufacturers as well as a number of innovative refrigeration and air conditioning companies.

A large number of development tasks have been completed; an extensive range of compressors and equipment is already available for the various alternative refrigerants.

Besides the development projects BITZER actively supports legal regulations and self commitments concerning the responsible use of refrigerants as well as measures to increase system efficiency.

The following report deals with possibilities for a short and medium term change to environmentally benign refrigerants in medium and large commercial refrigeration and A/C plants. At the same time, the experience which already exists is also dealt with and the resulting consequences for plant technology.



The results of several studies confirm that the vapour compression refrigeration plants normally used in the commercial field are far superior to all other processes down to a cold space temperature of around -40°C.

The selection of an alternative refrigerant and the system design receives special significance, however. Besides the request for substances without ozone depletion potential (ODP=0) especially the energy demand of a system is seen as an essential criterion due to its indirect contribution to the greenhouse effect. On top of that there is the direct global warming potential (GWP) due to refrigerant emission.

Therefore a calculation method has been developed for the qualified evaluation of a system which enables an analysis of the total influence on the greenhouse effect.

In this connection the so-called "TEWI" factor (Total Equivalent Warming Impact) has been introduced. Meanwhile, another, more extensive assessment method has been developed under the aspect of "Eco-Efficiency". Hereby, both ecological (such as TEWI = Total Equivalent Warming Impact) and economical criteria are taken into account.

Therefore it is possible that in future the assessment of refrigerants with regard to

the environment could differ according to the place of installation and drive method.

A closer look on the HFC based substitutes shows, however, that the possibilities for directly comparable single substance refrigerants are limited. The situation for R12 with the substitute R134a is relatively favourable, as it is for R502 with the alternatives R404A and R507A. It is more critical for alternatives to other CFC refrigerants and also for HCFCs, e.g. R22.

The refrigerants R32, R125 and R134a are regarded as direct substitutes from the line of HFCs. These however can only be used exceptionally as a pure substance due to their specific characteristics. Most important criteria in this concern are flammability, thermodynamic properties and global warming potential. These substances are much more suitable as components of blends where the individual characteristics can be matched to the requirements according to the mixing proportions.

Besides HFC refrigerants, Ammonia (NH₃) and hydrocarbons are considered as substitutes as well. The use for commercial applications, however, is limited by strict safety requirements.

Carbon dioxide (CO₂) becomes more important as an alternative refrigerant and secondary fluid, too. Due to its specific characteristics, however, there are restrictions to a general application.

The illustrations on the next pages show a structural survey of the alternative refrigerants and a summary of the single or blended substances which are now available. After that the individual subjects are discussed.

Due to the increasing interest in substitutes for R114, R12B1, R13B1, R13 and R503, the possible alternatives are also considered in this report.

Refrigerant data, application ranges and lubricant specifications are shown on pages 36 to 39.

For reasons of clarity the less or only regionally known products are not specified in this issue, which is not intended to imply any inferiority.

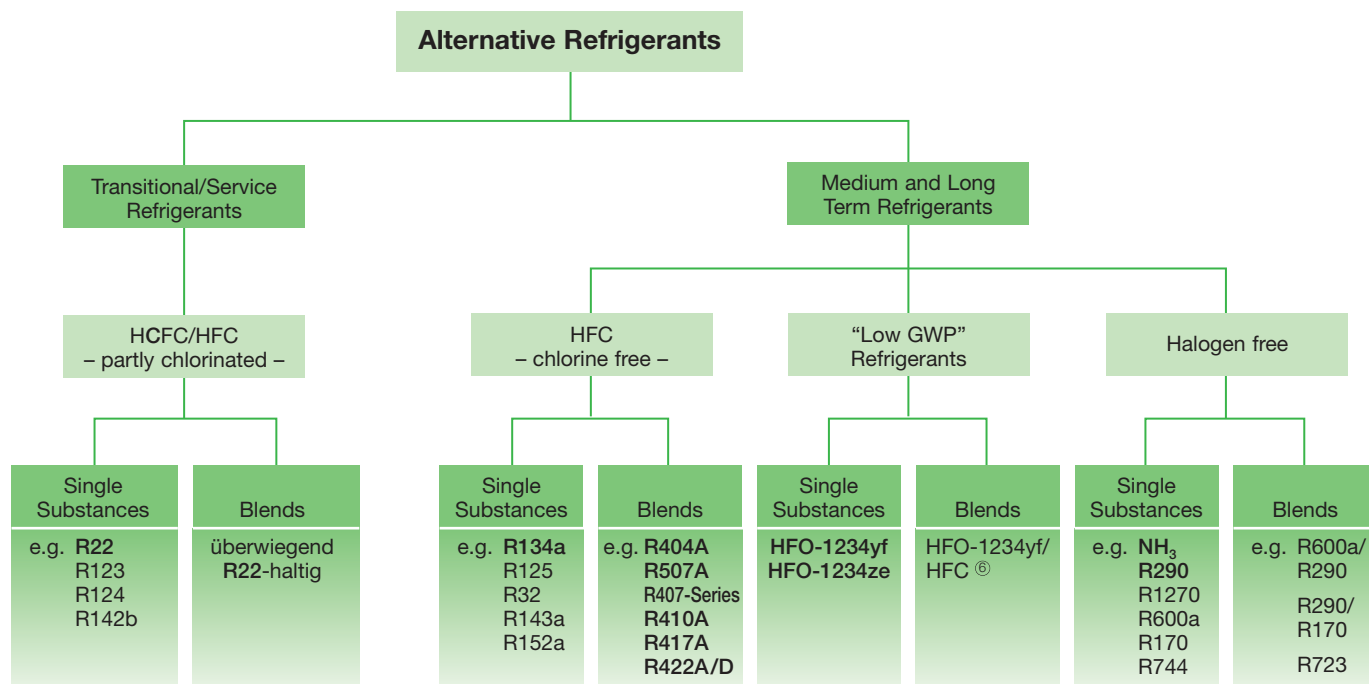

Fig. 1 General survey of the alternative refrigerants

Transitional / Service refrigerants

09.10

Previous refrigerants ¹	Alternatives				
	ASHRAE Classification	Trade name		Composition (with blends)	Detailed Information
R12 (R500)	R401A R401B R409A	MP39 MP66 FX56	DuPont DuPont Arkema/Solvay	R22/152a/124 R22/152a/124 R22/124/142b	pages 16, 36...39
R502	R22 R402A R402B R403B R408A	– HP80 HP81 – FX10	– DuPont DuPont DuPont Arkema	– R22/125/290 R22/125/290 R22/218/290 R22/143a/125	pages 8, 15, 16, 36...39
R114 R12B1	R124 ^③ R142b ^{① ③}	– –	– –	– –	pages 33, 36...39
R13B1 R13 R503	Alternatives see Fig. 3 “Chlorine free HCFC Refrigerants”				

The listed service refrigerants belong to the group of HCFC or contain these substances as blend component. They are therefore subject to the same legal regulations as R22 (see page 8).

Fig. 2 Alternatives for CFC refrigerants (transitional / service refrigerants)

Chlorine free (HFC) refrigerants and blends (long term alternatives)

09.10

Previous Refrigerants	Alternatives				
	ASHRAE Classification	Trade name		Composition (with blends)	Detailed Informationen
R12 (R500)	R134a R152a ^① R437A ^④	– ISCEON MO49 Plus	DuPont	R125/134a/600/601	pages 9...11, 16, 36...39
	HFO-1234yf ^⑥	various			page 11
R502/R22	R404A R507A R422A	various various ISCEON MO79	DuPont	R143a/R125/R134a R143a/125 R125/134a/600a	pages 17...19, 36...39
R22	R407A	various	Mexichem	R32/125/134a	pages 18...23, 36...39
	R407C	various		R32/125/134a	
	R407F	Performax LT	Honeywell	R32/125/134a	
	R410A	various		R32/125	
	R417A	ISCEON MO59	DuPont	R125/134a/600	
	R417B	Solkane 22L	Solvay	R125/134a/600	
	R422D	ISCEON MO29	DuPont	R125/134a/600a	
	R427A R438A	Forane 427A ISCEON MO99	Arkema DuPont	R32/125/143a/134a R32/125/134a/600/601a	
R114 R12B1	R236fa R227ea	– –	– –	– –	pages 33, 36...39
R13B1	R410A –	various ISCEON MO89	DuPont	R32/125 R125/218/290	pages 34, 36...39
R13 R503	R23 R508A R508B	– KLEA 508A Suva 95	Mexichem DuPont	– R23/116 R23/116	pages 34, 36...39

Fig. 3 Alternatives for CFC and HCFC refrigerants (chlorine free HFC refrigerants)

Halogen free refrigerants (long term alternatives)

09.10

Previous Refrigerants	Alternatives				
	ASHRAE Classification	Trade name		Formula	Detailed Information
R12 (R500)	R290/600a ^① R600a ^{①③}	– –		C ₃ H ₈ /C ₄ H ₁₀ C ₄ H ₁₀	pages 26, 36...39
R502	R717 ^{①②} R290 ^① R1270 ^①	– – –		NH ₃ C ₃ H ₈ C ₃ H ₆	pages 24...28, 36...39
R22	R717 ^{①②} R723 ^{①②⑤} R290 ^① R1270 ^①	– – – –		NH ₃ NH ₃ + R-E170 C ₃ H ₈ C ₃ H ₆	pages 24...28, 36...39
R114 R12B1	R600a ^①	–		C ₄ H ₁₀	pages 33, 36...39
R13B1	no direct alternatives available				
R13 R503	R170 ^①	–		C ₂ H ₆	pages 34, 36...39
Diverse	R744 ^③	–		CO ₂	pages 29...32, 36...39

Fig. 4 Alternatives for CFC and HCFC refrigerants (halogen free refrigerants)

Explanation of Fig. 2 to 4

- ① Inflammable
- ② Toxic
- ③ Large deviation in refrigerating capacity and pressures to the previous refrigerant
- ④ Service refrigerant with zero ODP
- ⑤ Azeotrope
- ⑥ In development and test phase

Global Warming and TEWI Factor

As already mentioned in the introduction a method of calculation has been developed, with which the influence upon the global warming effect can be judged for the operation of individual refrigeration plants (TEWI = Total Equivalent Warming Impact).

All halocarbon refrigerants, including the non-chlorinated HFCs belong to the category of the greenhouse gases. An emission of these substances contributes to the global warming effect. The influence is however much greater in comparison to CO₂ which is the main greenhouse gas in the atmosphere (in addition to water vapour). Based on a time horizon of 100 years, the emission from 1 kg R134a is for example roughly equivalent to 1300 kg of CO₂ (GWP₁₀₀ = 1300). It is already apparent from these facts that the reduction of refrigerant losses must be one of the main tasks for the future.

On the other hand, the major contributor to a refrigeration plant's global warming effect is the (indirect) CO₂ emission caused by energy generation. Based on the high percentage of fossil fuels used in power stations the average European CO₂ release is around 0.6 kg per kWh of electrical energy. A significant greenhouse effect occurs over the lifetime of the plant as a result of this.

As this is a high proportion of the total balance it is also necessary to place an increased emphasis upon the **use of high efficiency compressors** and associated equipment as well as optimized system components, in addition to the demand for alternative refrigerants with favourable (thermodynamic) energy consumption.

When various compressor designs are compared, the difference of indirect CO₂ emission (due to the energy requirement) can have a larger influence upon the total effect as the refrigerant losses.

A usual formula is shown in Fig. 5, the TEWI factor can be calculated and the various areas of influence are correspondingly separated.

In addition to this an example in Fig. 6 (medium temperature with R134a) shows

the influence upon the TEWI value with various refrigerant charges, leakage losses and energy consumptions.

This example is simplified based on an overall leak rate as a percentage of the refrigerant charge. As is known the practical values vary very strongly whereby the potential risk with individually constructed systems and extensively branched plants is especially high.

Great effort is taken worldwide to reduce greenhouse gas emissions and legal regulations have partly been developed already. Since 2007, the "Regulation on certain fluorinated greenhouse gases" (No. 842/2006) – which also defines stringent requirements for refrigeration and air-conditioning systems – has become valid for the EU.

TEWI = TOTAL EQUIVALENT WARMING IMPACT

$$TEWI = (GWP \times L \times n) + (GWP \times m [1 - \alpha_{\text{recovery}}]) + (n \times E_{\text{annual}} \times \beta)$$

← Leakage → Recovery losses → ← Energy consumption →
 ← direct global warming potential → ← indirect global warming potential →

GWP	= Global warming potential	[CO ₂ -related]
L	= Leakage rate per year	[kg]
n	= System operating time	[Years]
m	= Refrigerant charge	[kg]
α _{recovery}	= Recycling factor	
E _{annual}	= Energy consumption per year	[kWh]
β	= CO ₂ -Emission per kWh	(Energy-Mix)

Fig. 5 Method for the calculation of TEWI figures

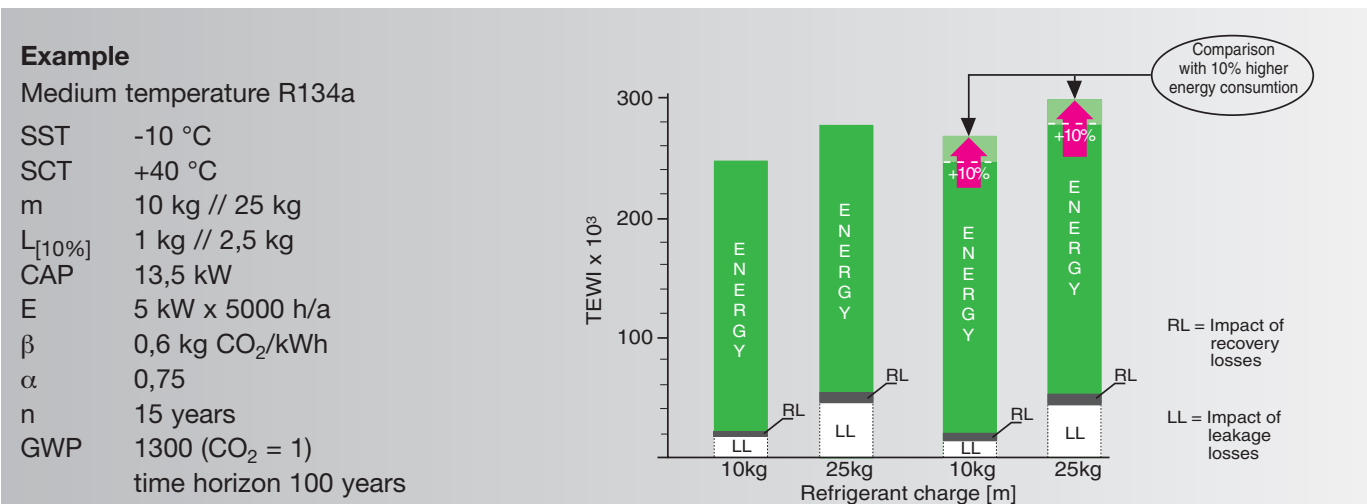

Fig. 6 Comparison of TEWI figures (example)

Eco-Efficiency

As mentioned above, an assessment based on the specific TEWI value takes into account the effects of global warming during the operating period of a refrigeration, air-conditioning or heat pump installation. Hereby, however, the entire ecological and economical aspects are not considered.

But apart from ecological aspects, when evaluating technologies and making investment decisions, economical aspects are highly significant. With technical systems, the reduction of environmental impact frequently involves high costs, whereas low costs often have increased ecological consequences. For most companies, the investment costs are decisive, whereas they are often neglected during discussions about minimizing ecological problems.

For the purpose of a more objective assessment, studies* were presented in 2005 and 2010, using the example of supermarket refrigeration plants to describe a concept for evaluating **Eco-**

Efficiency. It is based on the relationship between added value (a product's economic value) and the resulting environmental impact.

With this evaluation approach, the entire life cycle of a system is taken into account in terms of:

- ❑ ecological performance in accordance with the concept of Life Cycle Assessment as per ISO 14040,
- ❑ economic performance by means of a Life Cycle Cost Analysis.

This means that the overall environmental impact (including direct and indirect emissions), as well as the investment costs, operating and disposal costs, and capital costs are taken into account.

The studies also confirm that an increase of Eco-Efficiency can be achieved by investing in optimized plant equipment (minimized operating costs). Hereby, the choice of refrigerant and the associated system technology plays an important role.

Eco-Efficiency can be illustrated in graphic representation (see example in Fig. 8). For this, the results of the Eco-Efficiency evaluation are shown on the x-axis in the system of coordinates,

whilst the results of the life cycle cost analysis are shown on the y-axis. This representation shows clearly that a system exhibits an increasingly better Eco-Efficiency, the higher it lies in the top right quadrant – and conversely, it becomes less efficient in the bottom left sector.

The diagonals plotted into the system of coordinates represent lines of equal Eco-Efficiency. This means that systems or processes with different life cycle costs and environmental impacts can quite possibly exhibit the same Eco-Efficiency.

* Study 2005: Compiled by Solvay Management Support GmbH and Solvay Fluor GmbH, Hannover, together with the Information Centre on Heat Pumps and Refrigeration (IZW), Hannover.

Study 2010: Compiled by SKM ENVIROS, UK, commissioned by and in cooperation with EPEE (European Partnership for Energy and Environment).

Both projects were supported by an advisory group of experts from the refrigeration industry.

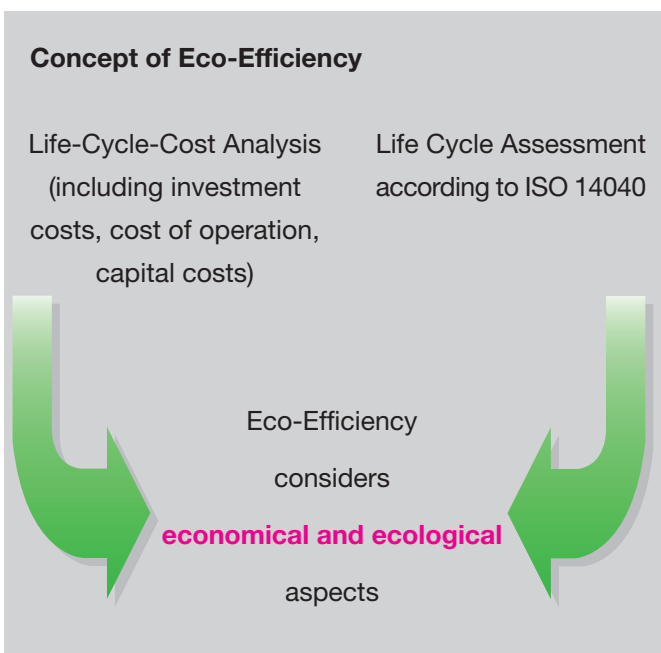

Fig. 7 Concept of Eco-Efficiency

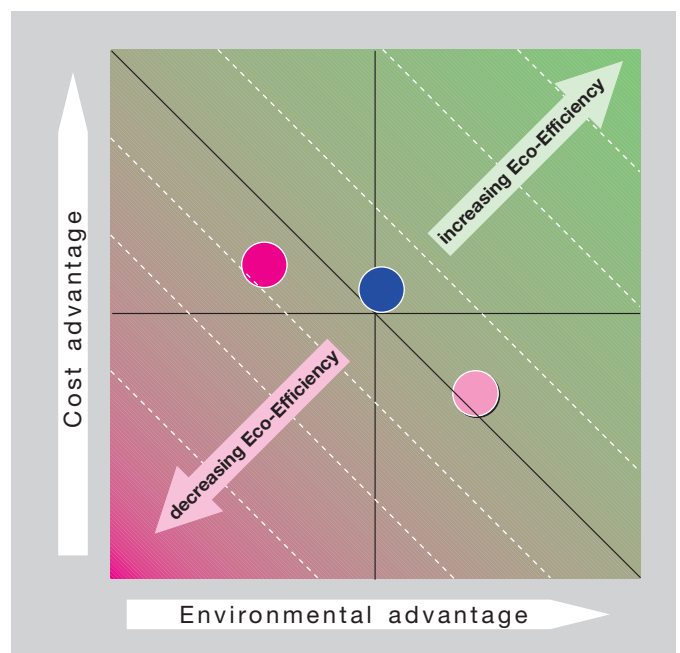

Fig. 8 Example of an Eco-Efficiency evaluation

R22 as transitional refrigerant

Although the chlorine free substitutes R134a and R404A/R507A (Fig. 1 and 3) have extensively made their way as substitutes for R12 and R502, in many international fields R22 is still used in new installations and for retrofitting of existing systems.

Reasons are relatively low investment costs, especially compared with R134a systems, but also in its large application range, favourable thermodynamic properties and low energy requirement. Additionally there is world wide availability of R22 and the proven components for it, which is not yet guaranteed everywhere with the chlorine free alternatives.

The latter is also true for the “zeotropic” service refrigerants (Fig. 1 and 2). Moreover, they predominantly contain R22 and therefore only make sense where pure R22 cannot be controlled due to high operation temperatures. Related to these mixtures special handling procedures are required (see section “Refrigerant blends” from page 13).

Despite of the generally favourable properties R22 is already subject to various

regional restrictions* which control the use of this refrigerant in new systems and for service purposes due to its ozone depletion potential – although being low.

With regard to components and system technology a number of particularities are to follow as well. Refrigerant R22 has approximately 55% higher refrigerating capacity and pressure levels in comparison to R12. The significantly higher discharge gas temperature is also a critical factor compared to R12 (see Fig. 9) and R502.

Similar relationships in terms of thermal load are found in the comparison with HFC refrigerants R134a, R404A/R507A (pages 9 and 17).

Suitable compressors are required for plants with R22, these have been available and are proven for medium temperature and air conditioning for a long time.

Refrigeration and air conditioning

Particularly critical – due to the high discharge gas temperature – are low temperature plants especially concerning thermal stability of oil and refrigerant, with the danger of acid formation and copper plating. Special measures have to be adopted therefore, such as two stage compression, controlled refrigerant injection, additional cooling, monitoring of discharge gas temperature, limiting the suction gas superheat and particularly careful installation.

A wide palette is available from BITZER for R22:

- ❑ *Open and semi-hermetic reciprocating compressors from 0.37 to 74 kW nominal motor power with special design features for low temperature use*
- ❑ *Open and semi-hermetic screw compressors from 15 to 220 kW nominal motor power (parallel operation to 620 kW) for single and two stage systems.*

* Not allowed for new equipment in Germany and Denmark since 2000 January 1st and in Sweden as of 1998. Since January 1st, 2001 restrictions apply to the other member states of the EU as well. The measures concerned are defined in the ODS Regulation 1005/2009 of the EU commission on ozone depleting substances amended in 2009. This regulation also governs the use of R22 for service reasons within the entire EU.

Since 2010, phase-out regulations in other countries, such as the USA, are valid. Information about the world wide R22 phase-out regulation can be found under www.arap.org/docs/regs.html as well.

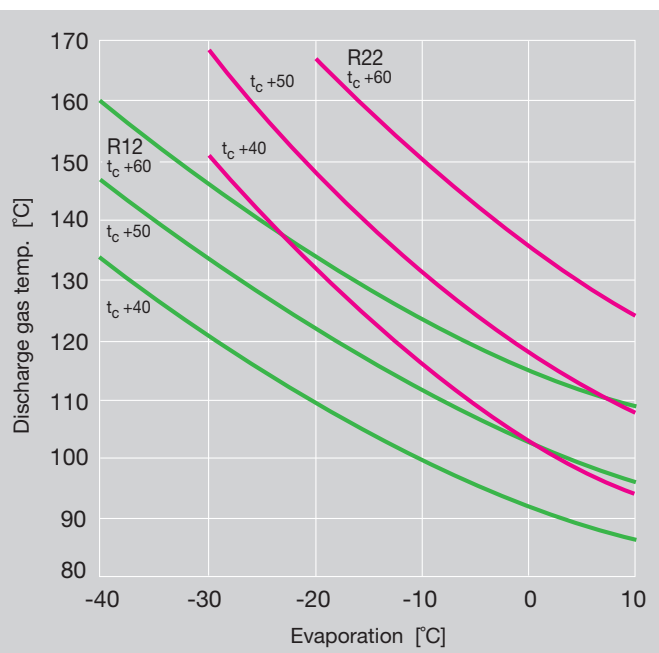

Fig. 9 R12/R22 – comparison of discharge gas temperatures of a semi-hermetic compressor

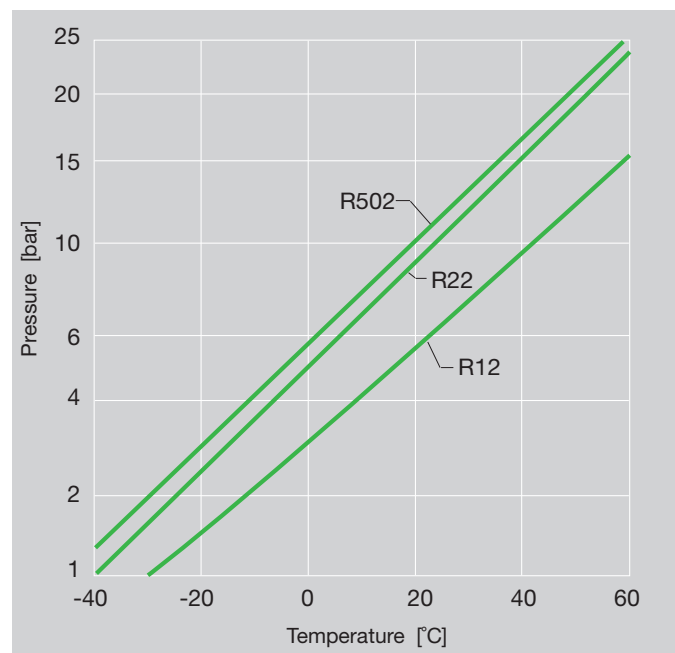

Fig. 10 R12/R22/R502 – comparison of pressure levels



R134a as substitute for R12 and R22

R134a was the first chlorine free (ODP = 0) HFC refrigerant that was tested comprehensively. It is now used world-wide in many refrigeration and air-conditioning units with good results. As well as being used as a pure substance R134a is also applied as a component of a variety of blends (see "Refrigerant blends", page 13).

R134a has similar thermodynamic properties to R12:

Refrigeration capacity, energy requirement, temperature properties and pressure levels are comparable, at least in air-conditioning and medium temperature refrigeration plants. This refrigerant can therefore be used as an alternative for most R12 applications.

For some applications **R134a is even preferred as a substitute for R22**, an important reason being the limitations to the use of R22 in new plants. However, the lower volumetric refrigeration capacity of R134a (see Fig. 11/2) requires a larger compressor displacement than with R22. There are also limitations in the applica-

tion with low evaporating temperatures to be considered.

Comprehensive tests have demonstrated that the performance of R134a exceeds theoretical predictions over a wide range of compressor operating conditions. Temperature levels (discharge gas, oil) are even lower than with R12 and, therefore, substantially lower than R22 values. There are thus many potential applications in air-conditioning and medium temperature refrigeration plants. Good heat transfer characteristics in evaporators and condensers (unlike zeotropic blends) favour particularly an economical use.

Lubricants for R134a and other HFCs

The question of a suitable lubricant for R134a (and other HFCs described in the following) has been found to be a problem. The traditional mineral and synthetic oils are not miscible (soluble) with R134a and are therefore only insufficiently transported around the refrigeration circuit. Immiscible oil can settle out in the heat exchangers and prevent heat transfer to such an extent that the plant can no longer be operated. New lubricants were developed with the appropriate solubility

and have by now been in use for many years. These lubricants are based on Polyol Ester (POE) and Polyalkylene Glycol (PAG).

They have similar lubrication characteristics to the traditional oils, but are more or less hygroscopic, dependent upon the refrigerant solubility.

This demands special care during manufacturing (including dehydrating), transport, storage and charging, to avoid chemical reactions in the plant, such as hydrolysis.

PAG based oils are especially critical with respect to water absorption. Moreover, they have a relatively low dielectric strength and for this reason are not very suitable for semi-hermetic and hermetic compressors. They are therefore mainly used in car A/C systems with open compressors, where specific demands are placed on lubrication and optimum solubility is required because of the high oil circulation rate. In order to avoid copper plating, no copper containing materials are used in these systems either.

The rest of the refrigeration industry prefers **ester oils**, for which extensive experience is already available. The results are generally positive when the

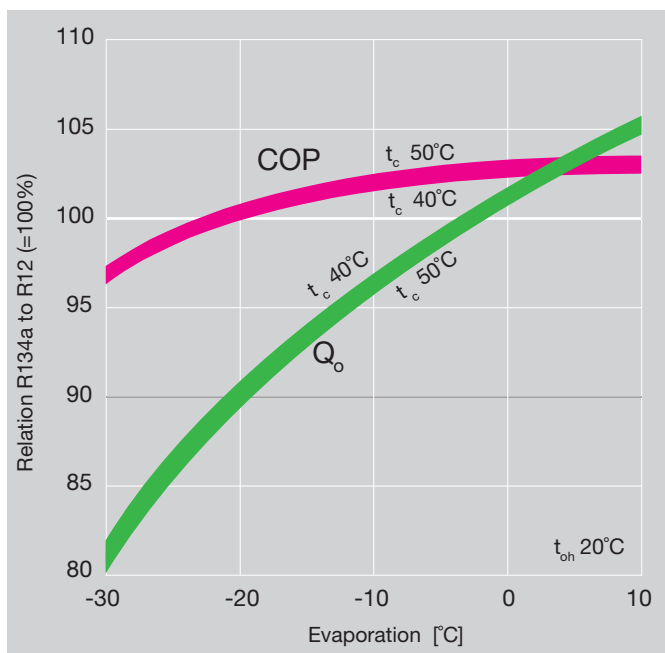

Fig. 11/1 R134a/R12 – comparison of performance data of a semi-hermetic compressor

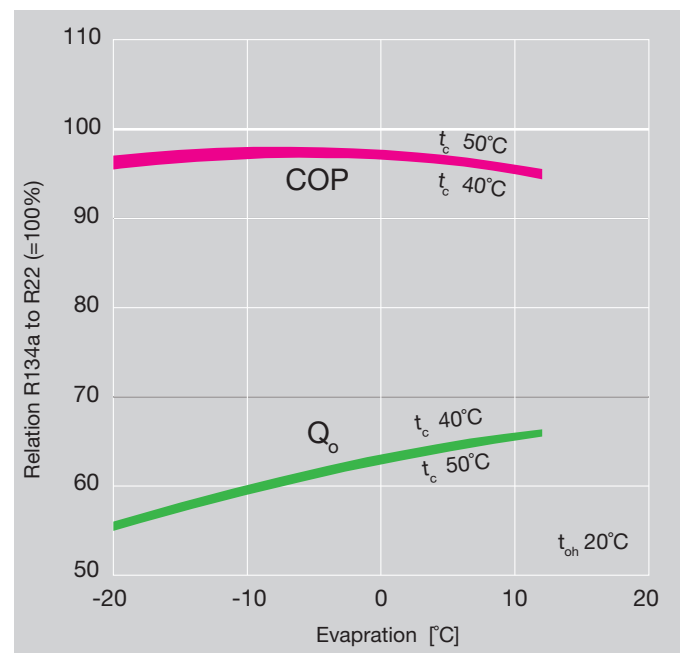

Fig. 11/2 R134a/R22 – comparison of performance data of a semi-hermetic compressor

water content in the oil does not much exceed 100 ppm.

In the meantime, compressors for factory made A/C and cooling units are increasingly being charged with **Polyvinyl Ether (PVE) oils**. Although they are even more hygroscopic than POE, on the other hand they are very resistant to hydrolysis, thermally and chemically stable, possess good lubricating properties and high dielectric strength. Unlike POE they do not tend to form metal soap and thus the danger of capillary clogging is reduced.

Resulting design and construction criteria

Suitable compressors are required for R134a with a special oil charge, and adapted system components. The normal metallic materials used in CFC plants have also been proven with ester oils; elastomers must sometimes be matched to the changing situation. This is especially valid for flexible hoses where the requirements call for a minimum residual moisture content and low permeability.

The plants must be dehydrated with particular care and the charging or changing

of lubricant must also be done carefully. In addition relatively large driers should be provided, which have also to be matched to the smaller molecule size of R134a.

Meanwhile, many years of very positive experience with R134a and ester oils have been accumulated. For this refrigerant, BITZER offers an unequalled wide range of reciprocating, screw, and scroll compressors.

Converting existing R12 plants

At the beginning this subject had been discussed very controversially, several conversion methods were recommended and applied. Today there is a general agreement on technically and economical matching solutions.

Here, the characteristics of ester oils are very favourable. Under certain conditions they can be used with CFC refrigerants, they can be mixed with mineral oils and tolerate a proportion of chlorine up to a few hundred ppm in an R134a system.

The remaining moisture content has however an enormous influence. The essential requirement therefore exists for very thorough evacuation (removal of remaining

chlorine and dehydration) and the installation of generously dimensioned driers. Doubtful experience has been found, with systems where the chemical stability was already insufficient with R12 operation e.g. with bad maintenance, small drier capacity, high thermal loading. The increased deposition of oil decomposition products containing chlorine often occurs here. These products are released by the working of the highly polarized mixture of ester oil and R134a and find their way into the compressor and regulating devices. Conversion should therefore be limited to systems which are in a good condition.

Restrictions for R134a in mobile air-conditioning (MAC) systems

In future, a new EU Directive on "Emissions from MAC systems" will ban the use of R134a in new systems. Several alternative technologies are already being developed. See the pertaining explanations on pages 12 and 31.

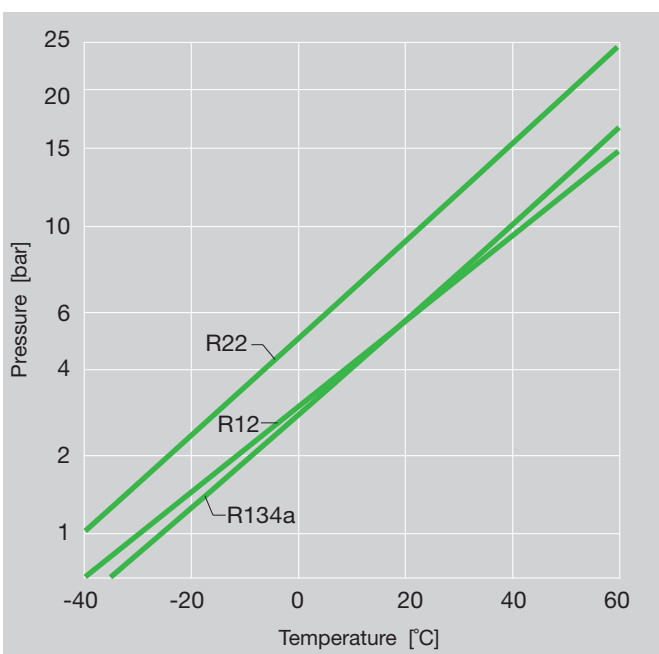

Fig. 12 R134a/R12/R22 – comparison of pressure levels

Supplementary BITZER information concerning the use of R134a

(see also <http://www.bitzer.de>)

- ❑ Semi-hermetic reciprocating compressors KP-103 "ECOLINE Series"
- ❑ Technical Information KT-620 "HFC-Refrigerant R134a"
- ❑ Technical Information KT-510 "Polyolester oils for reciprocating compressors"
- ❑ Special edition 09.04 "A new generation of compact screw compressors optimised for R134a"

Alternatives to R134a

For mobile air-conditioning systems (MAC) with open drive compressors and hose connections in the refrigerant circuit, the risk of leakages is considerably higher than with stationary systems. With a view to reducing direct emissions in this application area, an EU Directive (2006/40/EC) has therefore been passed. Within the scope of the Directive, and starting 2011, type approvals for new vehicles will only be granted if they use refrigerants with a global warming potential (GWP) of less than 150. Consequently, this excludes R134a which has been used so far in these systems (GWP = 1300).

Meanwhile, alternative refrigerants and new technologies are being developed and tested. This also involved a closer examination of the use of R152a. Since some time, the focus has been on specially adapted CO₂ plants (see page 31) as well as system solutions with so-called "low GWP" refrigerants. The latter will be described in the following.

R152a – an alternative to R134a (?)

Compared to R134a, R152a is very similar with regard to volumetric cooling capacity (approx. -5%), pressure levels (approx. -10%) and energy efficiency. Mass flow, vapour density and thus also the pressure drop are even more favourable (approx. -40%).

R152a has been used for many years as a component in blends but not as a single substance refrigerant till now. Especially advantageous is the very low global warming potential (GWP=140).

R152a is inflammable – due to its low fluorine content – and classified in safety group A2. As a result, increased safety requirements demand individual design solutions and safety measures along with the corresponding risk analysis.

For this reason, the use of R152a in MAC systems is rather unlikely.

"Low GWP" refrigerant HFO-1234yf and 1234ze

The forthcoming ban on the use of R134a in mobile air-conditioning systems within the EU has triggered a series of research projects. Apart from the CO₂ technology (page 31), new refrigerants with very low GWP values and similar thermodynamic properties as R134a have been developed.

In early 2006, two refrigerant mixtures were introduced under the names "Blend H" (Honeywell) and "DP-1" (DuPont). INEOS Fluor followed with another version under the trade name AC-1. In the broadest sense, all of these refrigerants were blends of various fluorinated molecules.

During the development and test phase it became obvious that not all acceptance criteria could be met, and thus further examinations with these blends were discontinued.

Consequently, DuPont* and Honeywell* bundled their research and development activities in a joint venture which focused on 2,3,3,3-tetrafluoropropene (CF₃CF=CH₂). This refrigerant with the name HFO-1234yf belongs to the group of fluoro olefins with carbon-carbon double chemical bond.

The global warming potential is extremely low (GWP₁₀₀ = 4) due to rapid decomposition in the atmosphere. This raises certain concerns regarding the long-term stability in refrigeration circuits under real conditions. However, extensive testing has demonstrated the required stability for mobile air-conditioning systems.

HFO-1234yf has mild flammability as measured by ASTM 681, but requires significantly more ignition energy than R152a, for instance. Due to its low burning velocity and the high ignition force, it would be expected to receive a classification of the new safety group "A2L" according to ISO 817. A comprehensive series of tests have proven that the mild flammability does not provide an extra risk for the mobile air-conditioning application.

Toxicity investigations have shown very positive results, as well as compatibility tests of the plastic and elastomer materials and lubricants used in the refrigeration circuit.

Operating experiences gained from laboratory and field trials to date allow a positive assessment, particularly with regard to performance and efficiency behaviour. For the usual range of mobile air-conditioning operation, cooling capacity and coefficient of performance (COP) are within a range of 5% compared with that of R134a. Therefore, it is expected that simple system modifications will provide the same performance and efficiency as with R134a.

The critical temperature and pressure levels are also similar, while the vapour densities and mass flows are approximately 20% higher. The discharge gas temperature is up to 10 K lower.

With a view to the relatively simple conversion of mobile air-conditioning systems, it is therefore likely that this technology will prevail over the competing CO₂ systems.

The use of HFO-1234yf in other mobile air-conditioning applications is also being considered, as well as in stationary A/C and heat pump systems. However, this must take into account the charge limitations for the A2(L) refrigerants (e.g. EN378), which will restrict their use accordingly. Additional concerns are those regarding the long-term stability in refrigeration circuits, given the usually very long life cycles of such systems.

For applications requiring the use of refrigerants of safety group A1 (neither flammable nor toxic), R134a alternatives of lower GWP based on HFO/HFC blends have already been developed. They have been tested for some time in real systems. For more information on these systems, see page 23, "HFO/HFC blends".

From the group of fluoro olefins, another substance under the name HFO-1234ze is available, which until now has been used predominantly as blowing agent for polyurethane foam and propellant. HFO-1234ze differs from HFO-1234yf by having a different molecular structure. Its thermodynamic properties also provide favourable conditions for the use as refrigerant. Its global warming potential is also very low (GWP = 6).

The volumetric refrigeration capacity and pressure levels are about 75% compared to HFO-1234yf. This makes HFO-1234ze also a potential candidate for extra high temperature systems. For further information, see page 34, "Special applications".

Refrigerant blends

Refrigerant blends have been developed for existing as well as for new plants with properties making them comparable alternatives to the previously used substances.

Although the situation is now less complex, the range on offer is nevertheless still very extensive.

It is necessary to distinguish between two categories:

1. Transitional or service blends

Most of these blends contain HCFC R22 as the main constituent. They are primarily intended as **service refrigerants for older plants** with view on the phase-out of R12, R502 and other CFCs.

Corresponding products are offered by various manufacturers, the practical experience covering the necessary steps of conversion procedure are available.

However, the same legal requirements apply for the use and phase-out regulations of these blends as for R22 (see page 8).

2. Chlorine free HFC blends

These are long term substitutes for the refrigerants R502, R22, R13B1 and R503. Above all, R404A, R507A, R407C and R410A, are already being used to a great extent.

One group of these HFC blends also contains hydrocarbon additives. The latter exhibit an improved solubility with lubricants, and under certain conditions they allow the use of conventional oils. In many cases, this opens up possibilities for the conversion of existing (H)CFC plants to chlorine-free refrigerants (ODP = 0) without the need for an oil change.

Two and three component blends already have a long history in the refrigeration trade. A difference is made between the so called "azeotropes" (e.g. R502, R507A) with thermodynamic properties similar to single substance refrigerants, and "zeotropes" with "gliding" phase changes

(see also next section). The development of "zeotropes" was mainly concentrated on special applications in low temperature and heat pump systems. Actual system construction remained however the exception.

A somewhat more common earlier practice was the mixing of R12 to R22 in order to improve the oil's return flow and to reduce the discharge gas temperature with higher pressure ratios. It was also usual to add R22 to R12 systems for improved performance, or to add hydrocarbons in the extra low temperature range for a better oil transport.

This possibility of specific "formulation" of certain characteristics was indeed the main starting point for the development of a new generation of blends.

As already mentioned earlier, no directly comparable substitute for R502 and R22 is available from the chlorine free single substance series of alternative refrigerants. A similar situation can be stated for R13B1 and R503.

If flammability is unacceptable, and toxicological certainty is required and in addition, application range, COP, pressure and temperature conditions are to be comparable, the only remaining substitutes for many applications are blends.

Substitutes for R502 had first priority, as it was used in larger quantities and is already effected by the phase-out regulations in many countries. The following discussion therefore, deals first with the established alternatives for this refrigerant and the results from the extensive applications in real systems.

Another focal point are **alternatives for R22**.

BITZER has already accumulated extensive experience with the new generation of blends. Laboratory and field testing was commenced at an early stage so that basic information was obtained for the optimizing of the mixing proportions and for testing suitable lubricants. Based on this data, a large

supermarket plant – with 4 semi-hermetics type 4G-20.2 in parallel – could already be commissioned at the start of '91.

The use of these blends in the most varied systems has been state-of-the-art for many years – generally with good experiences.

General characteristics of zeotropic blends

As opposed to azeotropic blends (e.g. R502, R507A), which behave as single substance refrigerants with regard to evaporation and condensing processes, the phase change with zeotropic fluids occurs in a "gliding" form over a certain range of temperature.

This "temperature glide" can be more or less pronounced, it is mainly dependent upon the boiling points and the percentage proportions of the individual components. Certain supplementary definitions are also being used, depending on the effective values, such as "near-azeotrope" or "semi-azeotrope" for less than 1 K glide.

This means in practice already a small increase in temperature in the evaporation phase and a reduction during condensing. In other words, based on a certain pressure the resulting saturation temperatures differ in the liquid and vapour phases (Fig. 13).

To enable a comparison with single substance refrigerants, the evaporating and condensing temperatures have been often defined as mean values. As a consequence the measured subcooling and superheating conditions (based on mean values) are unreal. The effective result – related to dew and bubble temperature – is less in each case.

These factors are very important when assessing the minimum superheat at the compressor inlet (usually 5 to 7 K) and the quality of the refrigerant after the liquid receiver.

With regard to a uniform and easily comprehensible definition of the rated com-

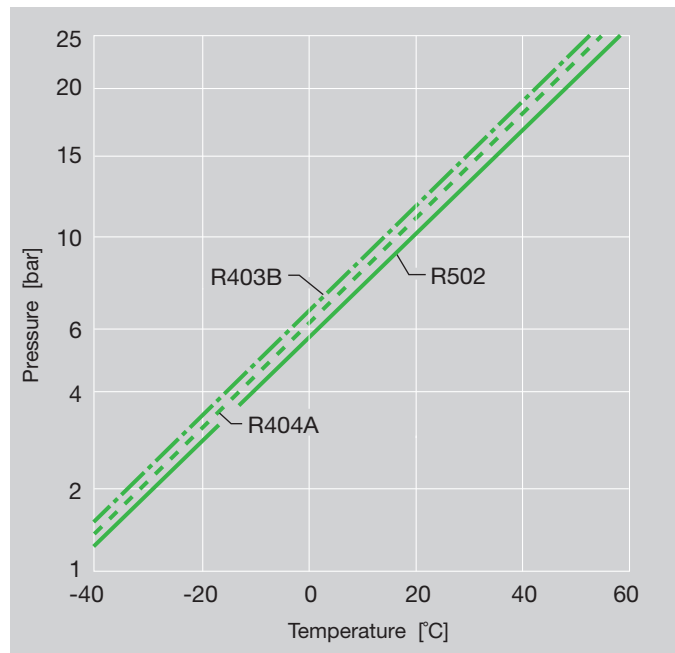
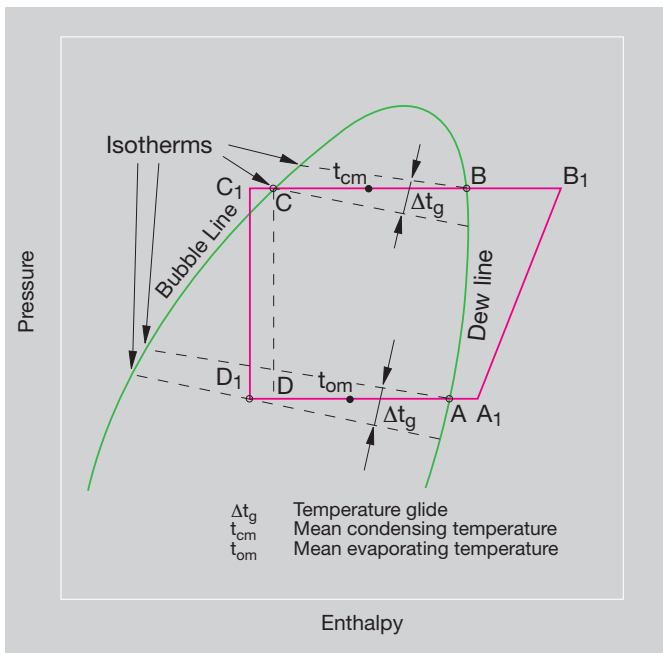

Fig. 13 Evaporating and condensing behavior of zeotropic blends

Fig. 14 Pressure levels of blends in comparison to R502

pressor capacity, the revised standards EN12900 and ARI540 are applied. Evaporating and condensing temperatures refer to saturated conditions (dew points).

- Evaporating temperature according to point A (Fig. 13).
- Condensing temperature according to point B (Fig. 13).

Also in this case the assessment of the effective superheating and subcooling temperatures will be simplified.

It must however be considered that the actual refrigeration capacity of the system can be higher than the rated compressor capacity. This is partly due to an effectively lower temperature at the evaporator inlet.

A further characteristic of zeotropic refrigerants is the potential concentration shift when leakage occurs. Refrigerant loss in the pure gas and liquid phases is mainly non-critical. Leaks in the phase change areas, e.g. after the expansion valve, within the evaporator and condenser/ receiver are considered more significant.

It is therefore recommended that soldered or welded joints should be used in these sections.

Extended investigations have in the meantime shown that the effect of leakage leads to less serious changes in concentration than was previously thought. It is in any case certain that the following substances which are dealt with here cannot develop any flammable mixtures, either inside or outside the circuit. Essentially similar operating conditions and temperatures as before can only be obtained by supplementary charging with the original refrigerant in the case of a small temperature glide.

Further conditions/recommendations concerning the practical handling of blends must also be considered:

- The plant always has to be charged with liquid refrigerant. When vapour is taken from the charging cylinder shifts in concentrations may occur.
- Since all blends contain at least one flammable component, the entry of air into the system must be avoided. A critical shift of the ignition point can occur under high pressure and evacuating when a high proportion of air is present.
- The use of blends with a significant temperature glide is not recommended for plants with flooded evaporators. A large concentration shift is to be expected in this type of evaporator, and as a result also in the circulating refrigerant mass flow.

Service blends with the basic component R22* as substitutes for R502

As a result of the continued refurbishment of older installations, the importance of these refrigerants is clearly on the decline. For some of them, production has already been discontinued. However, for development-historic reasons of service blends, these refrigerants will continue to be covered in this report.

These refrigerants belong to the group of "Service blends" and are offered under the designations R402A/R402B* (HP80/HP81 – DuPont), R403A/R403B* (formerly ISCEON 69S/69L) and R408A* ("Forane" FX10 – Arkema).

The basic component is in each case R22, the high discharge gas temperature of which is significantly reduced by the addition of chlorine free substances with low isentropic compression exponent (e.g. R125, R143a, R218). A characteristic feature of these additives is an extraordinarily high mass flow, which enables the mixture to achieve a great similarity to R502. R290 (Propane) is added as the third component to R402A/B and R403A/B to

improve miscibility with traditional lubricants as hydrocarbons have especially good solubility characteristics.

For these blends two variations are offered in each case. When optimizing the blend variations with regard to identical refrigeration capacity as for R502 the laboratory measurements showed a significantly increased discharge gas temperature (Fig. 15), which above all, with higher suction gas superheat (e.g. supermarket use) leads to limitations in the application range.

On the other hand a higher proportion of R125 or R218, which has the effect of reducing the discharge gas temperature to the level of R502, results in somewhat higher cooling capacity (Fig. 16).

With regard to material compatibility the blends can be judged similarly to (H)CFC refrigerants. The use of conventional refrigeration oil (preferably semi or full synthetic) is also possible due to the R22 and R290 proportions.

Apart from the positive aspects there are also some disadvantages. These substances can also only be seen as alternatives for a limited time. The R22 proportion has (although low) an ozone depletion

potential. The additional components R125, R143a and R218 still have a comparatively high global warming potential.

**Resulting design criteria/
Converting existing R502 plants**

The compressor and the components which are matched to R502 can remain in the system in most cases. The limitations in the application range must however be considered: Higher discharge gas temperature as for R502 with R402B**, R403A** and R408A** or higher pressure levels with R402A** and R403B**.

Due to the good solubility characteristics of R22 and R290 an increased danger exists, that after conversion of the plant, possible deposits of oil decomposition products containing chlorine may be dissolved and find their way into the compressor and regulating devices. Systems where the chemical stability was already insufficient with R502 operation (bad maintenance, low drier capacity, high thermal loading) are particularly at risk.

* When using blends containing R22 legal regulations are to be observed, see also page 8.
** Classification according to ASHRAE nomenclature.

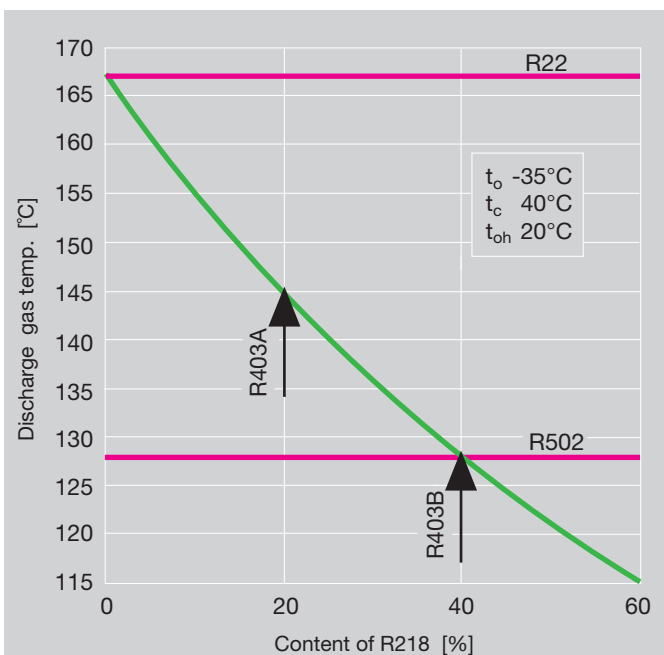

Fig. 15 Effect of the mixture variation upon the discharge gas temperature (example: R22/R218/R290)

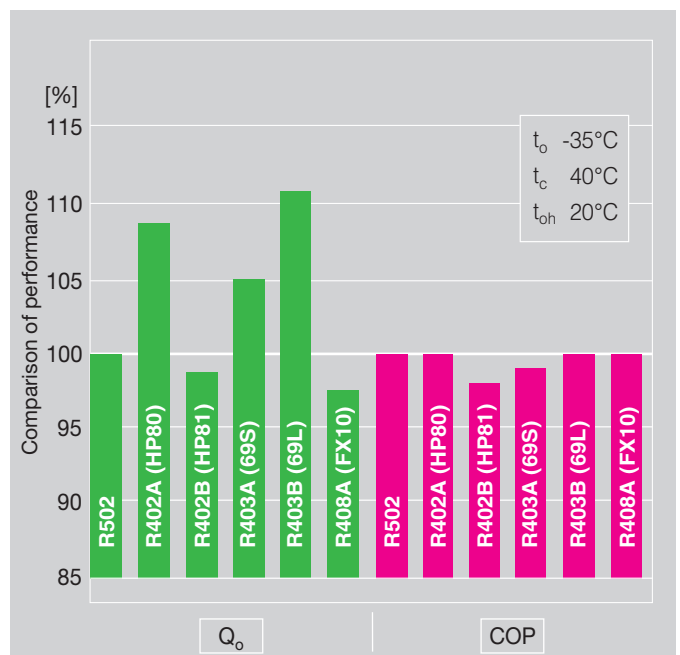

Fig. 16 Comparison of the performance data of a semi-hermetic compressor

Before conversion generously dimensioned suction gas filters and liquid line driers should therefore be fitted for cleaning and after approximately 100 hours operation an oil change should be made; further checks are recommended.

The operating conditions with R502 (including discharge gas temperature and suction gas superheat) should be noted so that a comparison can be made with the values after conversion. Depending upon the results regulating devices should possibly be reset and other additional measures should be taken as required.

Supplementary BITZER information concerning the use of retrofit blends
(see also <http://www.bitzer.de>)

- Technical Information KT-650 "Retrofitting of R12 and R502 refrigerating systems to alternative refrigerants"

Service blends as substitutes for R12 (R500)

Although as experience already shows, R134a is also well suited for the conversion of existing R12 plants, the general use for such a "retrofit" procedure is not always possible. Not all compressors which have previously been installed are designed for the application with R134a. In addition a conversion to R134a requires the possibility to make an oil change, which is for example not the case with most hermetic type compressors.

Economical considerations also arise, especially with older plants where the effort in converting to R134a is relatively high. The chemical stability of such plants is also often insufficient and therefore the chance of success is very questionable. Therefore "Service blends" are also available for such plants as an alternative to R134a and are offered under the designations R401A/R401B (MP39/MP66 – DuPont), R409A ("Forane" FX56 – Arkema, Solvay). The main components are the HCFC refrigerants R22, R124 and/or R142b. Either HFC R152a or R600a (Isobutane)

is used as the third component. Operation with traditional lubricants (preferably semi or full synthetic) is also possible due to the major proportion of HCFC.

A further service blend was offered under the designation R413A (ISCEON49 – DuPont), but replaced by R437A by the end of 2008. However, for development-historic reasons of service blends, R413A will continue to be covered in this report. The constituents consist of the chlorine free substances R134a, R218, and R600a. In spite of the high R134a content the use of conventional lubricants is possible because of the relatively low polarity of R218 and the favourable solubility of R600a.

R437A is a blend of R125, R134a, R600 and R601 with similar performance and properties as R413A. This refrigerant also has zero ODP

However, due to the limited miscibility of R413A and R437A with mineral and alkylbenzene oils, oil migration may result in systems with a high oil circulation rate and/or a large liquid volume in the receiver – for example if no oil separator is installed.

If insufficient oil return to the compressor is observed, the refrigerant manufacturer recommends replacing part of the original oil charge with ester oil. But from the compressor manufacturer's view, such a measure requires a very careful examination of the lubrication conditions. For example, if increased foam formation in the compressor crankcase is observed, a complete change to ester oil will be necessary. Moreover, under the influence of the highly polarized blend of ester oil and HFC, the admixture of or conversion to ester oil leads to increased dissolving of decomposition products and dirt in the pipework. Therefore, generously dimensioned suction clean-up filters must be provided.

For further details, see the refrigerant manufacturer's "Guidelines".

**Resulting design criteria/
Converting existing R12 plants**

Compressors and components can mostly remain in the system. However, when using R413A and R437A the suitability must be checked against HFC refrigerants. The actual "retro-fit" measures are mainly restricted to changing the refrigerant (possibly oil) and a careful check of the superheat setting of the expansion valve.

A significant temperature glide is present due to the relatively large differences in the boiling points of the individual substances (Fig. 34, page 35), which demands an exact knowledge of the saturation conditions (can be found from vapour tables of refrigerant manufacturer) in order to assess the effective suction gas superheat.

In addition the application range must also be observed.

Different refrigerant types are required for high and low evaporating temperatures or distinct capacity differences must be considered (data and application ranges see pages 36 to 39). This is due to the steeper capacity characteristic, compared to R12.

Due to the partially high proportion of R22 especially with the low temperature blends, the discharge gas temperature with some refrigerants is significantly higher than with R12. The application limits of the compressor should therefore be checked before converting.

The remaining application criteria are similar to those for the substitute substances for R502 which have already been mentioned.

* By using R22 containing blends the legal requirements are to be followed, see also page 8.

Supplementary BITZER information concerning the use of retrofit blends
(see also <http://www.bitzer.de>)

- Technical Information KT-650 "Retrofitting of R12 and R502 refrigerating systems to alternative refrigerants"



R404A and R507A as substitutes for R502 and R22

These blends are chlorine free substitutes (ODP = 0) for R502 as well as for R22 in medium and low temperature ranges.

A composition which was already launched at the beginning of '92 is known under the trade name „Suva“ HP62 (DuPont). Long term use has shown good results. Further blends were traded as „Forane“ FX70 (Atofina/Arkema) and “Genetron” AZ50 (Allied Signal/Honeywell) or “Solkanne” 507 (Solvay). In the mean time HP62 and FX70 have been listed in the ASHRAE nomenclature as R404A and AZ50 as R507A.

The basic components belong to the HFC group, where R143a belongs to the flammable category. Due to the combination with a relatively high proportion of R125 the flammability is effectively counteracted and also in the case of leakage.

A feature of all three ingredients is the very low isentropic compression exponent which results in a similar, with even a ten-

dency to be lower, discharge gas temperature to R502 (Fig. 17). The efficient application of single stage compressors with low evaporating temperatures is therefore guaranteed.

Due to the similar boiling points for R143a and R125, with a relatively low proportion of R134a, the temperature glide with the ternary blend R404A within the relevant application range is less than one Kelvin. The characteristics within the heat exchangers are not therefore very different as with azeotropes. The results obtained so far from heat transfer measurements show favourable conditions.

R507A is a binary substance combination which even gives an azeotropic characteristic over a relatively wide range. The conditions therefore tend to be even better.

The performance found in laboratory tests (Fig. 18) gives hardly any difference between the various substances and show a large amount of agreement with R502. This justifies the good market penetration of these substitutes.

Questions concerning material compatibility are manageable; experience with other HFCs justifies a positive assessment.

POE oils can be used as lubricants; the suitability of various alternatives is being investigated as well (see pages 9/10).

The relatively high global warming potential ($GWP_{100} = 3780...3850$) which is mainly determined by the R143a and R125 is something of a hitch. It is however improved compared to R502 and which with regard also to the favourable energy requirement leads to a reduction of the TEWI value. Other improvements are possible in this respect due to further developed system control including for example the controlled lowering of the condensing temperature with low ambient temperatures.

Resulting design criteria

The system technology can be based on the experience with R502 over a wide area. On the thermodynamic side, a heat exchanger between the suction and liquid line is recommended as this will improve the refrigeration capacity and COP.

The availability of the refrigerants is guaranteed.

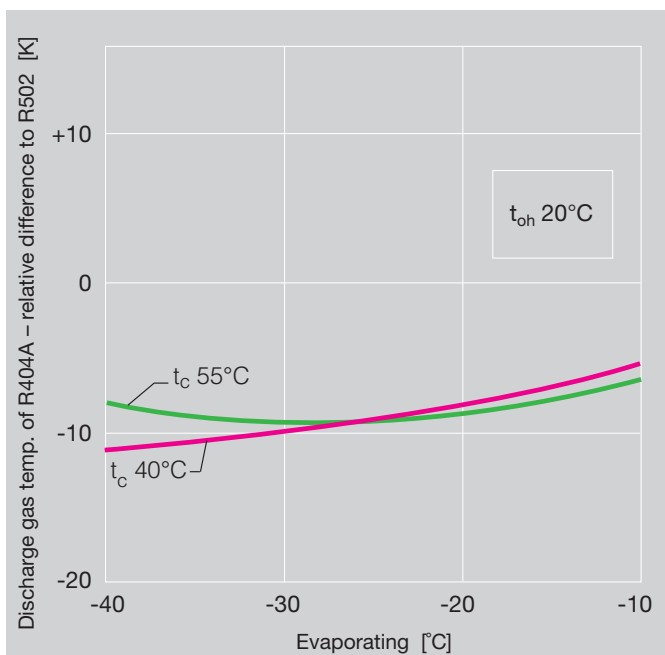

Fig. 17 R404A/R502 – comparison of discharge gas temperatures of a semi-hermetic compressor

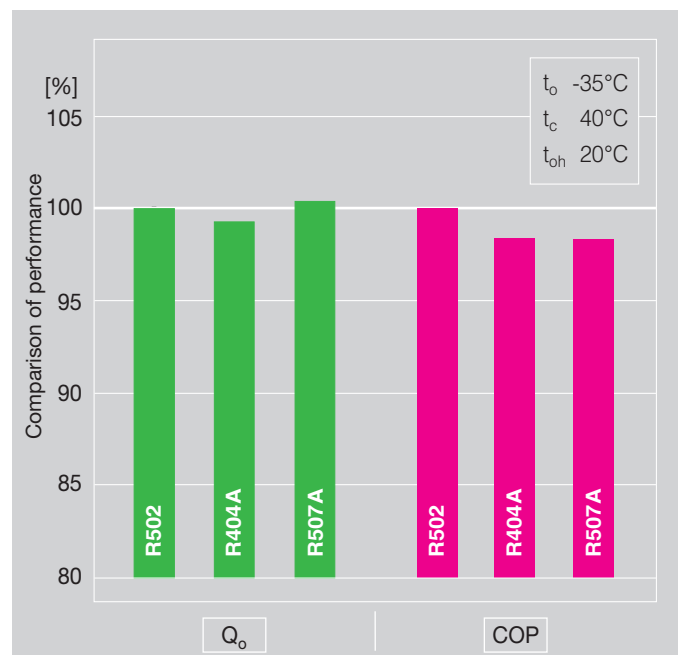

Fig. 18 Comparison of performance data of a semi-hermetic compressor

BITZER offers the whole program of reciprocating, scroll and screw compressors for these blends.

R407A/R407B/R407F as substitutes for R502 and R22

Converting existing (H)CFC plants

Experience gained in investigative programs shows that qualified conversions are possible. However, major expenditure may be necessary depending on the system design.

Alternatively to the earlier described substitutes additional mixture versions have been developed based on R32 which is chlorine free (ODP = 0) and flammable like R143a.

The refrigerant R32 is also of the HFC type and primarily seen as a candidate for R22 alternatives (page 20). Due to the extent of the blend variations however comparable thermodynamic characteristics to R502 can also be obtained.

Such kind of refrigerants were at first in the market under the trade name KLEA 60/61 (ICI) and are listed as R407A/R407B* in the ASHRAE nomenclature.

The necessary conditions, however, for R502 alternatives containing R32 are not quite as favourable compared to the R143a based substitutes as dealt with earlier. The boiling point of R32 is very low at -52°C , in addition the isentropic compression exponent is similarly high as with R22. To match the characteristics of R502 therefore requires relatively high proportions of R125 and R134a. The flammability of the R32 is thus effectively sup-

pressed, at the same time the large differences in the boiling points with a high proportion of R134a leads to a larger temperature glide.

The main advantage of R32 is the extraordinarily low global warming potential ($\text{GWP}_{100} = 550$) so that even in combination with R125 and R134a it is significantly lower than with the R143a based alternatives mentioned above.

Measurements made with R32 containing blends do show certain capacity reductions compared to R502 as well as R404A and R507A, with low evaporating temperatures, the COP however shows less deviation (Fig. 20). The TEWI values are relatively low, together with the advantageous global warming potential.

Where these favourable prospects are confirmed in real applications is subject to the system criteria.

An important factor is the significant temperature glide which can have a negative influence upon the capacity/temperature difference of the evaporator and condenser. With regard to the material compatibility, R32 blends can be assessed similarly to the HFC substitutes described before; the same applies to the lubricants.

Supplementary BITZER information concerning the use of HFC blends (see also <http://www.bitzer.de>)

- Technical Information KT-651 "Retrofitting of R22 systems to alternative refrigerants"
- Technical Information KT-510 "Polyolester oils for reciprocating compressors"

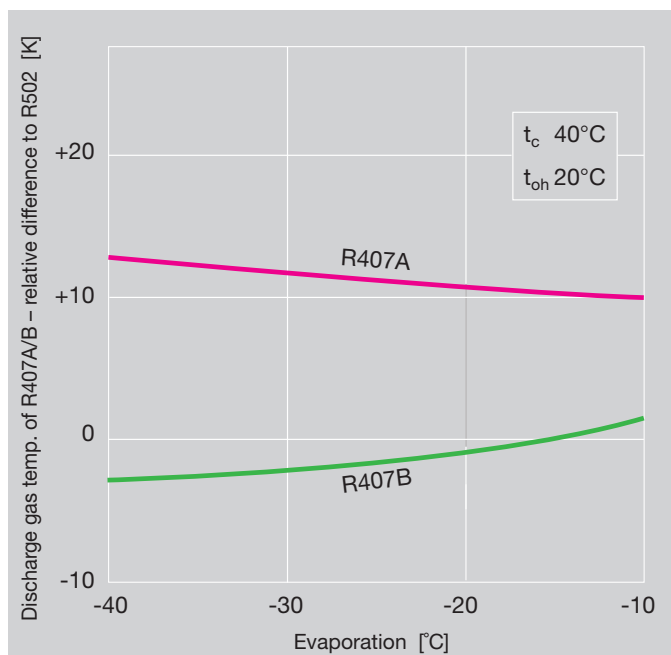

Fig. 19 Comparison of discharge gas temperature of a semi-hermetic compressor

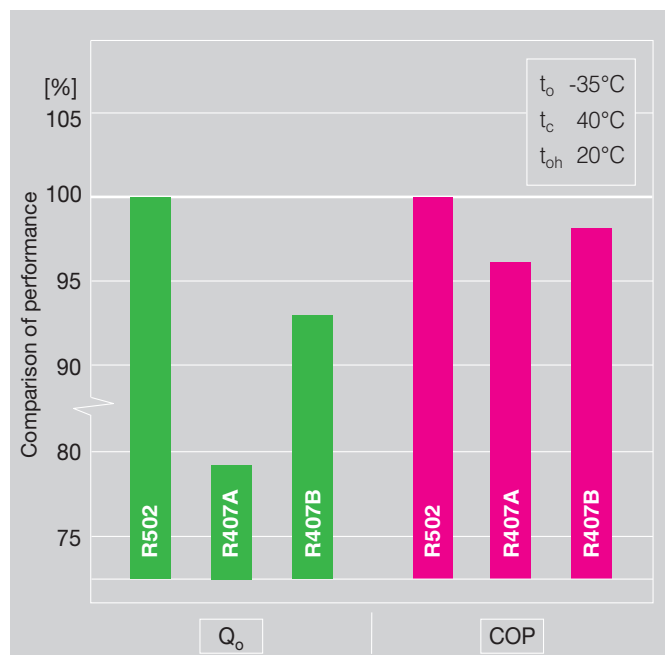

Fig. 20 Comparison of performance data of a semi-hermetic compressor

Despite the relatively high proportion of R125 and R134a in the R32 blends aimed at R502 characteristics, the discharge gas temperature is somewhat higher than with the R143a based alternatives. As a result certain limitations occur in the application range.

From this point of view, but also with regard to the efficiency an intelligent control is recommended for controlled floating of the condensing pressure with low ambient temperatures.

2-stage compressors can be applied very efficiently where especially large lift conditions are found. An important advantage thereby is the use of a liquid subcooler.

Resulting design criteria

The experience with R502 and R22 can be used for the plant technology in many respects, considering the temperature glide as well as the difference in the thermodynamic properties. This is especially the case for designing and constructing heat exchangers and expansion valves.

The refrigerants are available. Occasionally, individual selection will be required for the necessary components.

* Meanwhile, R407B is no longer available in the market. Due to the historical development of HFC blends this refrigerant will, however, still be considered in this Report.

Converting existing CFC plants

Practical experiences show that qualified conversions are possible. Compared to R22 the volumetric refrigeration capacity is nearly similar while the refrigerant mass flow is only slightly higher. These are relatively favourable conditions for the conversion of medium and low temperature R22 systems.

This is also true for a blend with the trade name Performax LT (probable designation R407F according to ASHRAE nomenclature) developed by Honeywell specifically for the retrofitting of R22 systems.

The main components can remain in the system provided that they are compatible with HFC refrigerants and ester oils. However, special requirements placed on the heat exchanger with regard to the signifi-

cant temperature glide must be considered. A conversion to ester oil is also necessary, which leads to increased dissolving of decomposition products and dirt in the pipework. Therefore, generously dimensioned suction clean-up filters must be provided.

Supplementary BITZER information concerning the use of HFC blends (see also <http://www.bitzer.de>)

- Technical Information KT-651 "Retrofitting of R22 systems to alternative refrigerants"

R422A as substitute for R502 and R22

Amongst other aims, R422A (ISCEON MO79 – DuPont) was developed in order to obtain a chlorine-free refrigerant (ODP = 0) for the simple conversion of existing medium and low temperature refrigeration systems using R502 and R22.

For this, it was necessary to formulate a refrigerant with comparable performance and energy efficiency to that of R404A, R507A, and R22, which also permits the use of conventional lubricants.

This pertains to a zeotropic blend of the basic components R125 and R134a with a small addition of R600a. Due to its relatively high R134a percentage, the temperature glide (Fig. 34) lies higher than for R404A, but lower than other refrigerants with the same component blends – such as R417A and R422D (see page 22).

The adiabatic exponent, compared to R404A and R507A, is smaller and therefore the discharge gas and oil temperatures of the compressor, too. Under extreme low temperature conditions this can be advantageous. In cases of low pressure ratio and suction gas superheat

this can be negative due to increased refrigerant solution if ester oil is used.

The material compatibility is comparable to the blends mentioned previously, the same applies to the lubricants, as well. On account of the good solubility of R600a, conventional lubricants can also be used under favourable circumstances.

In particular, advantages result during the conversion of existing R502 and R22 systems as mentioned above. However, for plants with high oil circulation rates and/or large liquid charge in the receiver, it is possible for oil migration to occur – for example if no oil separator is installed.

If insufficient oil return to the compressor is observed, the refrigerant manufacturer recommends replacing part of the original oil charge with ester oil. But from the compressor manufacturer's view, such a measure requires a very careful examination of the lubrication conditions. For example, if increased foam formation in the compressor crankcase is observed, a complete change to ester oil* will be necessary. Under the influence of the highly polarized blend of ester oil and HFC, the admixture of or conversion to ester oil leads to increased dissolving of decomposition products and dirt in the pipework. Therefore, generously dimensioned suction clean-up filters must be provided.

For further details, see the refrigerant manufacturer's "Guidelines".

From a thermodynamic point of view a heat exchanger between suction and liquid line is recommended, thereby improving the cooling capacity and coefficient of performance. Besides this the resulting increase in operating temperatures leads to more favourable lubricating conditions (lower solubility).

* General proposal for screw compressors and liquid chillers when used with DX evaporators with internally structured heat exchanger pipes. Furthermore, an individual check regarding possible additional measures will be necessary.

BITZER compressors are suitable for R422A. An individual selection is possible upon demand.

Chlorine free R22 alternatives

As the HCFC refrigerant R22 (ODP=0.05) is still widely accepted only as a transitional solution, a number of chlorine-free (ODP=0) alternatives have been developed and tested extensively. They are already being used on a large range of applications.

Experience shows, however, that none of these substitutes can replace the refrigerant R22 in all respects. Amongst other things there are differences in the volumetric refrigeration capacity, restrictions in possible applications, special requirements in system design or also considerably differing pressure levels. So various alternatives come under consideration according to the particular operating conditions.

Apart from the single-component HFC refrigerant R134a, these are mainly blends (different compositions) of the components R32, R125, R134a, R143a, and R600(a). The following description mainly concerns the development and potential applications of these. The halogen-free substitutes NH₃, propane and propylene as well as CO₂ should also be considered, however, specific criteria must be applied for their use (described from page 23).

R407C as substitute for R22

Blends of the HFC refrigerants R32, R125 and R134a are seen as the favourite candidates for shortterm substitution for R22 – their performance and efficiency are very similar (Fig. 21). At first two blends of the same composition have been introduced under the trade names AC9000* (DuPont) and KLEA66* (ICI). They are listed in the ASHRAE nomenclature as R407C. In the meantime there are also further blend varieties (e.g. R407D**/R407E/R407F***) with somewhat differing compositions, whose properties have been optimized for particular applications.

Unlike the R502 substitutes with identical blend components (see pages 18/19), the R22 substitutes under consideration contain higher proportions of R32 and R134a. A good correspondence with the properties of R22 in terms of pressure levels, mass flow, vapour density and volumetric refrigeration capacity is thus achieved. In addition, the global warming potential is

relatively low (GWP₁₀₀ = 1650), which is a good presupposition for favourable TEWI values.

The high temperature glide is a disadvantage for usual applications which requires appropriate system design and can have a negative influence on the efficiency of the heat exchangers (see explanations on pages 13/14).

Due to the properties mentioned, R407C is preferably an R22 substitute for air-conditioning systems and (within certain limitations) also for medium temperature refrigeration. In low temperature refrigeration, because of the high proportion of R134a, a significant drop in cooling capacity and COP is to be expected. There is also the danger of an increased R134a concentration in the blend in evaporators, with consequential reduction in performance and malfunctioning of the expansion valve (e.g. insufficient suction gas superheat).

Material compatibility can be assessed as similar to that of the blends discussed previously; the same applies to the lubricants.

** Because of the high proportion (70%) of R134a contained in R407D this refrigerant cannot be regarded as an alternative to R22, but rather as a substitute to R12 for low temperature cooling.

*** See page 18.

* Previous trade names are not used any more.

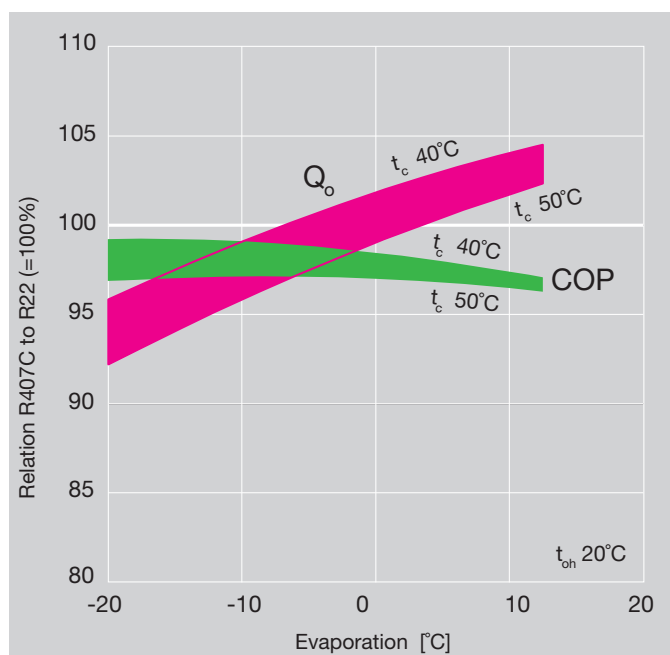

Fig. 21 R407C/R22 – comparison of performance data of a semi-hermetic compressor

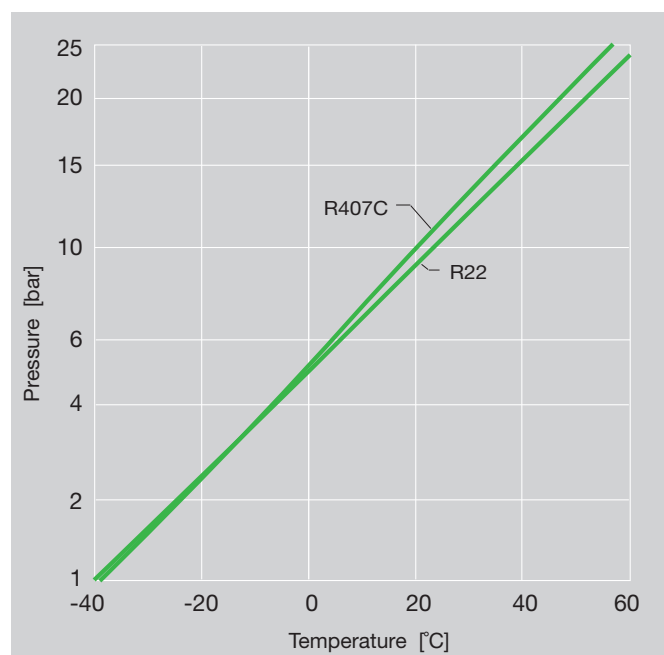

Fig. 22 R407C/R22 – comparison of pressure levels



Resulting design criteria

With regard to system technology, previous experience with R22 can only be utilized to a limited extent. The distinctive temperature glide requires a particular design of the main system components, e.g. evaporator, condenser, expansion valve. In this context it must be considered that heat exchangers should preferably be laid out for counterflow operation and with optimized refrigerant distribution. There are also special requirements with regard to the adjustment of regulating devices and service handling.

Furthermore, the use in systems with flooded evaporators is not recommended as this would result in a severe concentration shift and layer formation in the evaporator.

BITZER can supply a widespread range of semi-hermetic reciprocating, screw and scroll compressors for R407C.

Converting existing R22 plants

A series of plants have been converted for test purposes. Because of the above mentioned criteria, however, no general guidelines can be defined. Each case must therefore be examined individually.

R410A as substitute for R22

In addition to R407C, there is a near azeotropic blend being offered with the ASHRAE designation R410A. It is widely used already, mainly in air conditioning applications.

An essential feature indicates nearly 50% higher cooling capacity (Fig. 23) in comparison to R22, but with the consequence of a proportional rise in system pressure.

At high condensing temperatures, energy consumption/COP initially seems to be

less favourable than with R22. This is mainly due to the thermodynamic properties. On the other hand, very high isentropic efficiencies are achievable (with reciprocating and scroll compressors), whereby the differences are lower in reality.

Added to this are the high heat transfer coefficients in evaporators and condensers determined in numerous test series, with resulting especially favourable operating conditions. With an optimized design, it is quite possible for the system to achieve a better overall efficiency than with other refrigerants.

Because of the negligible temperature glide (< 0.2 K), the general usability can be seen similar to a pure refrigerant.

The material compatibility is comparable to the previously discussed blends and the same applies for the lubricants. However, the pressure levels and the higher specific loads on the system components need to be taken into account.

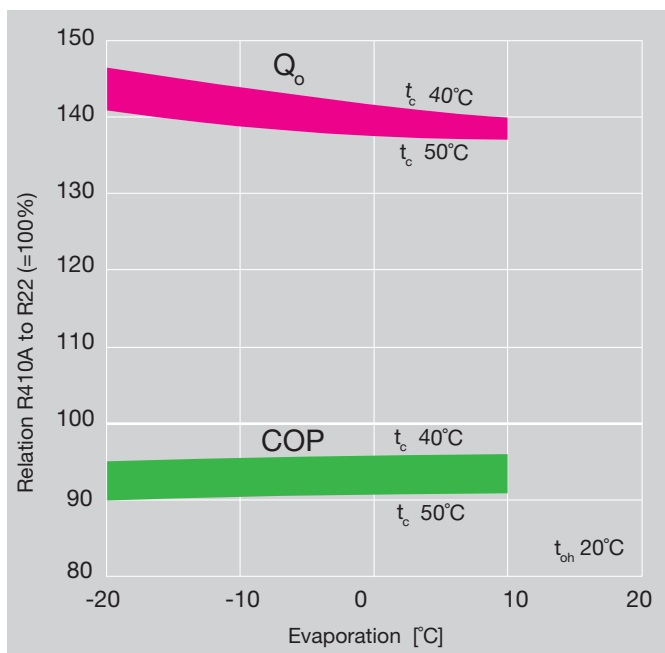

Fig. 23 R410A/R22 – comparison of performance data of a semi-hermetic compressor

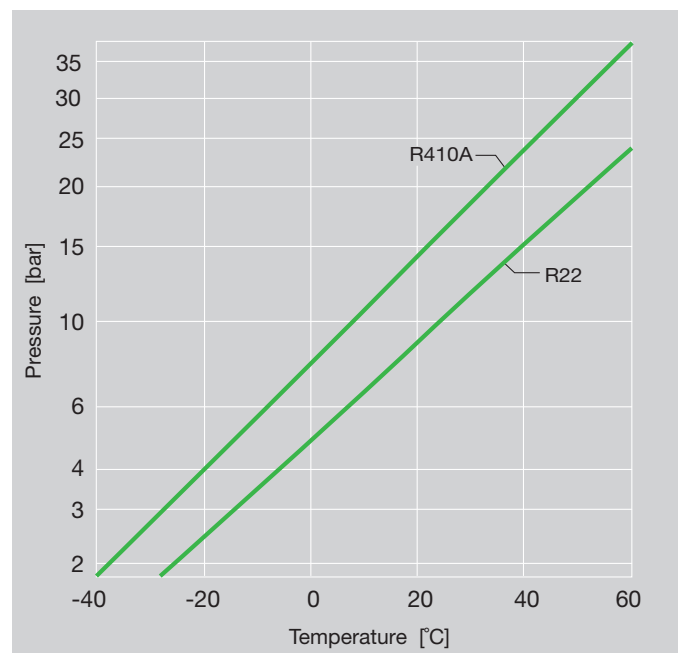

Fig. 24 R410A/R22 – comparison of pressure levels

Resulting design criteria

The fundamental criteria for HFC blends also apply to the system technology with R410A, however the extreme high pressure levels have to be considered (43°C condensing temperature already corresponds to 26 bar abs.).

Compressors and other system components of "standard design" have substantial limitations for the application of this refrigerant. However, due to the favourable properties of R410A considerable effort is taken for the development of suitable products.

When considering to cover usual R22 application ranges, the significant differences in the thermodynamic properties (e.g. pressure levels mass and volume flow, vapour density) must be evaluated.

This also requires considerable constructional changes to compressors, heat exchangers, and controls, as well as measures of tuning vibrations.

In addition, safety requirements are concerned also affecting the quality and dimensions of piping and flexible tube elements (for condensing temperatures of approx. 60°C/40 bar).

Another criterion is the relatively low critical temperature of 73°C. Irrespective of the design of components on the high pressure side, the condensing temperature is thus limited.

Already very early *BITZER* has conducted comprehensive research with R410A and accompanied by a series of projects. Meanwhile, two series of Octagon® and scroll compressors for R410A are available.

R417A/417B/422D/438A as substitutes for R22

The same as for R422A (page 19), one of the aims for these developments was to provide chlorine-free refrigerants (ODP = 0) for the simple conversion of existing R22 plants.

R417A was introduced to the market several years ago, and is also offered under the trade name ISCEON MO59 (DuPont). This substitute for R22 contains the blend components R125/R134a/R600, and therefore differs considerably from e.g. R407C with a correspondingly high proportion of R32.

Meanwhile, a further refrigerant based on identical components, but with a higher R125 content, has been offered under the trade name Solkane 22L (Solvay) – ASHRAE classification R417B. Due to its lower R134a content, the volumetric refrigerating capacity as well as the pressure levels are higher than with R417A. This results in different performance parameters and emphasis in the application range.

The same applies to a further blend with the same main components, but R600a as hydrocarbon additive. It is offered under trade name ISCEON MO29 (DuPont) and listed as R422D in the ASHRAE nomenclature.

A refrigerant also belonging to the category of HFC/HC blends was introduced in 2009 under the trade name ISCEON MO99 (DuPont) – ASHRAE classification R438A. This formulation was selectively designed for a higher critical temperature for applications in hot climate areas. The base components are R32, R125, R134a, R600 and R601a.

Like R407C, all four substitute refrigerants are zeotropic blends with a more or less significant temperature glide. In this respect the criteria described in connection with R407C are also valid.

Despite similar refrigeration capacity there are fundamental differences in thermodynamic properties and in oil transport behaviour. The high proportion of R125 causes with R417A/B and R422D a higher

mass flow than with R407C, a lower discharge gas temperature and a relatively high superheating enthalpy. These properties indicate that there could be differences in the optimization of system components and a heat exchanger between liquid and suction lines might be of advantage.

Despite the predominant proportion of HFC refrigerants the use of conventional lubricants is possible to some extent because of the good solubility properties of the hydrocarbon constituent. However, in systems with a high oil circulation rate and/or a large volume of liquid in the receiver oil migration may result.

In such cases, additional measures are necessary. For further information on oil return and lubricants, see the previous section on "R422A as substitute for R502 and R22" (page 19).

BITZER compressors are suitable for the described refrigerants. An individual selection is possible upon demand.

R427A as a substitute for R22

This refrigerant blend was introduced some years ago under the trade name Forane FX100 (Arkema). In the meantime it is listed in the ASHRAE nomenclature as R427A.

This R22 substitute is offered for the conversion of existing R22 systems for which a "Zero ODP" solution is requested. This refrigerant is a HFC mixture with base components R32/R125/R143a/R134a.

In spite of the blend composition based on pure HFC refrigerants, the manufacturer states that a simplified conversion procedure is possible.

This is positively influenced by the R134a proportion. Accordingly, when converting from R22 to R427A, all it takes is a replacement of the original oil charge with ester oil. Additional flushing sequences are not required, as proportions of up to 15% of mineral oil and/or alkyl benzene have no significant effect on oil circulation in the system.

However, it must be taken into account that under the influence of the highly polarized mixture of ester oil and HFC increased dissolving of decomposition products and dirt in the pipework is caused. Therefore, generously dimensioned suction clean-up filters must be provided.

An individual compressor selection is possible upon demand.

Supplementary information concerning the use of HFC blends (see also <http://www.bitzer.de>)

- Technical information KT-651
"Retrofitting R22 systems to alternative refrigerants"

HFO/HFC blends as HFC alternatives

Due to progress made with the use of the "Low GWP" refrigerant HFO-1234yf (see pages 11/12) in automotive air-conditioning systems, the development of alternatives for other mobile applications and stationary systems has meanwhile also been initiated.

The primary goals are the formulation of blends with significantly reduced GWP while maintaining similar thermodynamic properties to those of the HFCs used predominantly today.

The base component is in each case HFO-1234yf, which is the preferred candidate from the group of fluoro olefins with a chemical double bond, due to its combination of properties. However, HFO-1234yf is inflammable (probable classification in safety group A2L). Moreover, its volumetric refrigerating capacity of approximately the same level as R134a is relatively low. Suitable substances from the HFO group with a higher volumetric capacity – as direct alternatives to R22, R404A, R410A, etc. – are not available.

This, in addition to the demand for non-flammable refrigerants and/or a higher volumetric refrigerating capacity, makes the blend of HFO-1234yf with an HFC a suitable choice.

However, due to the properties of the HFC refrigerants suitable as blend components, flammability and GWP are related diametrically to one another. In other words: Blends as alternatives to R22, R404A, R410A, etc. that have a GWP < 500 are inflammable (A2L). Some of the non-flammable substances have a significantly higher GWP, but at a substantially lower level than the equivalent pure HFCs.

The situation is most favourable for non-flammable R134a alternatives. For them, GWP values \leq 600 can be achieved. This is less than half compared with R134a. In addition to that, this type of blend versions can have azeotropic properties, which is why they can be used like pure refrigerants.

For some time, a blend with the name DR-11 developed by DuPont has been investigated in compressor tests and pilot plants under real conditions. The results available to date are promising. However, a conclusive evaluation of the suitability of this refrigerant in long-term use is not yet possible at the present time. This is why investigation will continue to a larger extent.

BITZER is strongly involved in these projects and has already gained important knowledge in the use of this refrigerant.

NH₃ (Ammonia) as alternative refrigerant

The refrigerant NH₃ has been used for more than a century in industrial and larger refrigeration plants. It has no ozone depletion potential and no direct global warming potential. The efficiency is at least as good as with R22, in some areas even more favourable; the contribution to the indirect global warming effect is therefore small. In addition it is incomparably low in price. Summarized, is this then an ideal refrigerant and an optimum substitute for R22 or an alternative for HFCs!? NH₃ has indeed very positive features, which can also be mainly exploited in large refrigeration plants.

Unfortunately there are also negative aspects, which restrict the wider use in the commercial area or require costly and sometimes new technical developments.

A disadvantage with NH₃ is the high isentropic exponent (NH₃=1.31 / R22= 1.18 / R12=1.14), that results in a discharge temperature which is even significantly higher than that of R22. Single stage compression is therefore already subject to certain restrictions below an evaporating temperature of around -10°C.

The question of suitable lubricants is also not satisfactorily solved for smaller plants in some kinds of applications. The oils used previously were not soluble with the refrigerant. They must be separated with complicated technology and seriously limit the use of "direct expansion evaporators" due to the deterioration in the heat transfer.

Special demands are made on the thermal stability of the lubricants due to the high discharge gas temperatures. This is especially valid when automatic operation is considered where the oil should remain for years in the circuit without losing any of its stability.

NH₃ has an extraordinarily high enthalpy difference and as a result a relatively small circulating mass flow (approximately 13 to 15% compared to R22). This feature which is favourable for large plants makes

the regulation of the refrigerant injection more difficult with small capacities.

A further criteria which must be considered is the corrosive action on copper containing materials; pipe lines must therefore be made in steel. Apart from this the development of motor windings resistant to NH₃ is also hindered. Another difficulty arises from the electrical conductivity of the refrigerant with higher moisture content.

Additional characteristics include toxicity and flammability, which require special safety measures for the construction and operation of such plants.

Resulting design and construction criteria

Based on the present "state of technology", industrial NH₃ systems demand totally different plant technology, compared to usual commercial systems.

Due to the insolubility with the lubricating oil and the specific characteristics of the refrigerant, high efficiency oil separators and also flooded evaporators with gravity or pump circulation are usually employed. Because of the danger to the public and to the product to be cooled, the evaporator often cannot be installed directly at the cold space. The heat transport must then take place with a secondary refrigerant circuit.

Two stage compressors or screw compressors with generously sized oil coolers, must already be used at medium pressure ratios, due to the unfavorable thermal behaviour.

Refrigerant lines, heat exchangers and fittings must be made of steel; larger size pipe lines are subject to examination by a certified inspector.

Corresponding safety measures and also special machine rooms are required depending upon the size of the plant and the refrigerant charge.

The refrigeration compressor is usually of "open" design, the drive motor is a separate component.

These measures significantly increase the expenditure involved for NH₃ plants, especially in the medium and smaller capacity area.

Efforts are therefore being made worldwide to develop simpler systems which can also be used in the commercial area.

A part of the research programs is dealing with part soluble lubricants, with the aim of improving oil circulation in the system. Simplified methods for automatic return of non-soluble oils are also being examined as an alternative.

BITZER is strongly involved in these projects and has a large number of compressors operating. The experiences up to now have revealed that systems with part soluble oils are difficult to govern. The moisture content in the system has an important influence on the chemical stability of the circuit and the wear of the compressor. Besides, high refrigerant dilution in the oil (wet operation, insufficient oil temperature) leads to strong wear on the bearings and other moving parts. This is due to the enormous volume change when NH₃ evaporates in the lubricated areas.

These developments are being done on a widely used program. The emphasis is also on alternative solutions for non-soluble lubricants.

Besides to this various equipment manufacturers have developed special evaporators, where the refrigerant charge can be significantly reduced.

In addition to this there are also solutions for the "sealing" of NH₃ plants. This deals with compact liquid chillers (charge below 50 kg), installed in a closed container and partly with an integrated water reservoir to absorb NH₃ in case of a leak. This type of compact unit can be installed in areas which were previously reserved for plants with halogen refrigerants due to the safety requirements.

It is still too early to give a final judgement concerning the extended use of compact NH₃ systems, in place of plants with HFC refrigerants and mainly conventional technology. From the purely technical viewpoint and presupposing an acceptable price level, it is anticipated that a wider range of products will become available.

The production program from BITZER today includes an extensive selection of optimized NH₃ compressors for various types of lubricants:

- Single stage open reciprocating compressors (displacement 19 to 152 m³/h with 1450 rpm) for air-conditioning, medium temperature and Booster applications
- Open screw compressors (displacement 84 to 535 m³/h – with parallel operation to 3200 m³/h with 2900 rpm) for air-conditioning, medium and low temperature cooling.
Options for low temperature cooling:
 - Single stage operation
 - Economiser operation
 - Booster operation

Conversion of existing plants

The refrigerant NH₃ is not suitable for the conversion of existing (H)CFC plants; they must be constructed completely new with all components.

Supplementary BITZER information concerning the application of NH₃
(see also <http://www.bitzer.de>)

- Technical Information KT-640 “Application of Ammonia (NH₃) as an alternative refrigerant”

R723 (NH₃/DME) as an alternative to NH₃

The previously described experiences with the use of NH₃ in commercial refrigeration plants with direct evaporation caused further experiments on the basis of NH₃ under the addition of an oil soluble refrigerant component. The main goals were an improvement of the oil transport characteristics and the heat transmission with conventional lubricants along with a reduced discharge gas temperature for the extended application range with single stage compressors.

The result of this research project is a refrigerant blend of NH₃ (60%) and dimethyl ether “DME” (40%), developed by the “Institut fuer Luft- und Kaeltetechnik, Dresden”, Germany (ILK), that has been tested in a series of real systems. As a largely inorganic refrigerant it received the designation R723 due to its average molecular weight of 23 kg/kmol in accordance to the standard refrigerant nomenclature.

DME was selected as an additional component for its properties of good solubility and high individual stability. It has a boiling point of -26°C, a relatively low adiabatic exponent, is non toxic and is available in a high technical standard of purity. In the given concentration NH₃ and DME form an azeotropic blend characterised by a slightly rising pressure level in comparison to pure NH₃. The boiling point lies at -36.5°C (NH₃ -33.4°C), 26 bar (abs.) of condensing pressure corresponds to 58.2°C (NH₃ 59.7°C).

The discharge gas temperature in air-conditioning and medium temperature ranges decrease by about 10 to 25 K (Fig. 25) and thereby allows for an extension of the application range to higher pressure

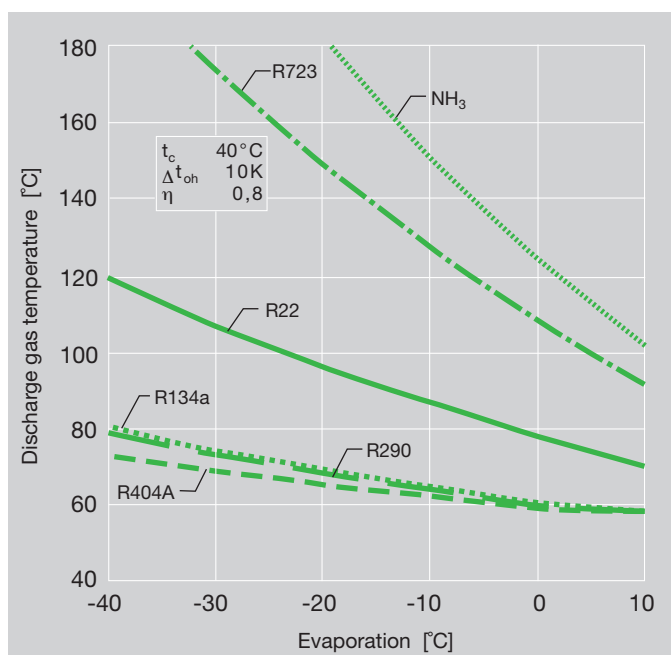

Fig. 25 Comparison of discharge gas temperatures

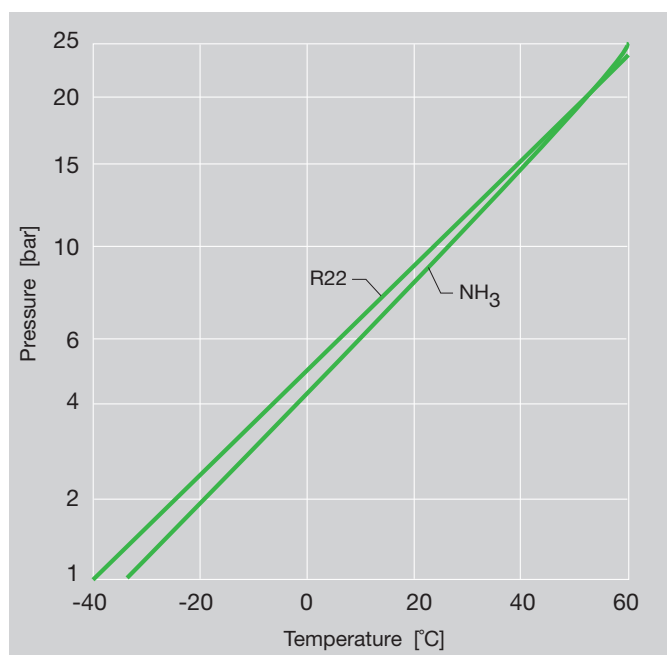

Fig. 26 NH₃/R22 – comparison of pressure levels

ratios. On the basis of thermodynamic calculations a single-digit percent rise in cooling capacity results when compared to NH_3 . The coefficient of performance is similar and is even more favourable at high pressure ratios, which experiments have confirmed. Due to the lower temperature level during compression an improved volumetric and isentropic efficiency is also to be expected, at least with reciprocating compressors in case of an increasing pressure ratio.

Due to the higher molecular weight of DME, mass flow and vapour density increase with respect to NH_3 by nearly 50% which is of little importance to commercial plants, especially in short circuits. In classical industrial refrigeration plants, however, this is a substantial criterion with regard to pressure drops and refrigerant circulation. Also from this standpoint it can be clearly seen that in commercial applications and especially in water chillers, R723 has its preferred utilisation.

The material compatibility is comparable to that of NH_3 . Although non-ferrous metals (e.g. CuNi alloys, bronze, hard solders) are potentially suitable, provided that the water content in the system is at a minimum (<1000 ppm), a system design that corresponds with typical ammonia practise is recommended nonetheless.

As lubricant mineral oils or (preferred) poly-alpha olefin can be used. As mentioned before the portion of DME creates improved oil solubility and a partial miscibility. Besides this the relatively low liquid density and an increased concentration of DME in the circulating oil, positively influences the oil circulation. PAG oils would be fully or partly miscible with R723 for typical applications but are not recommended for reasons of the chemical stability and high solubility in the compressor crankcase (strong vapour development in the bearings).

Tests have shown that the heat transfer coefficient at evaporation and high heat flux is improved in systems with R723 and mineral oil than when using NH_3 with mineral oil.

Further characteristics are toxicity and flammability. By means of the DME content, the ignition point in air diminishes from 15 to 6% but, despite of this, the azeotrope still remains in the safety group B2.

Resulting layout criteria

The experiences made with the NH_3 compact systems described above can be used in the plant technology. However, adjustments in the component layout are necessary under consideration of the higher mass flow. Besides a suitable selection of the evaporator and the expansion valve a very stable superheat control must be ensured. Due to the improved oil solubility "wet operation" can have considerable negative results when compared to NH_3 systems with non-soluble oil.

With regards to safety regulations the same criteria apply to installation and operation as in the case of NH_3 plants.

Suitable compressors are special NH_3 versions which possibly have to be adapted to the mass flow conditions and to the continuous oil circulation. An oil separator is usually not necessary with reciprocating compressors.

Bitzer NH_3 reciprocating compressors are suitable for R723 in principle. An individual selection of specifically adapted compressors is possible on demand.

R290 (Propane) as substitute for R502 and R22

R290 (propane) can also be used as a substitute refrigerant. As it is an organic compound (hydrocarbon) it does not have an ozone depletion potential and a negligible direct global warming effect. To take into consideration however, is a certain contribution to summer smog.

The pressure levels and the refrigeration capacity are similar to R22 and the temperature behaviour is as favourable as with R134a.

There are no particular material problems. In contrast to NH_3 copper materials are also suitable, so that semi-hermetic and hermetic compressors are possible. The mineral oils usually found in a HCFC system can be used here as a lubricant over a wide application range.

Refrigeration plants with R290 have been in operation world-wide for many years, mainly in the industrial area – it is a "proven" refrigerant.

Meanwhile R290 is also used in smaller compact systems with low refrigerant charges like residential A/C units and heat pumps. Furthermore, a rising trend can be seen in its use with commercial refrigeration systems and chillers.

Propane is offered also as a mixture with Isobutane (R600a) or Ethan (R170). This should obtain a good performance match with halocarbon refrigerants. Pure Isobutane is mostly intended as a substitute for R12 in small plants (preferably domestic refrigerators).

The disadvantage of hydrocarbons is the high flammability, and therefore been classified as refrigerants of "Safety Group A3". With the normal refrigerant charge found in commercial plants this means that the system must be designed according to "flame-proof" regulations.

The use of semi-hermetic compressors in so called "hermetically sealed" systems is in this case subject to the regulations for danger zone 2 (only seldom and short term risk). The demands for the safety technology include special devices to protect against excess pressures and special arrangements for the electrical system. In addition measures are required to ensure hazard free ventilation to effectively prevent a flammable gas mixture occurring in case of refrigerant leakage.

The design requirements are defined by standards (e.g. EN378, Draft DIN 7003) and may vary in different countries. For systems applied within the EU an assessment according to the EC Directive 94/9/EC (ATEX) may become necessary as well.



With open compressors this will possibly lead to a classification in zone 1. Zone 1 demands, however, electrical equipment in special flame-proof design.

Resulting design criteria

Apart from the measures mentioned above, propane plants require practically no special features in the medium and low temperature ranges compared with a usual (H)CFC and HFC system. When sizing components consideration should however be given to the relatively low mass flow (approximately 55 to 60% compared to R22). An advantage in connection with this is the possibility to greatly reduce the refrigerant charge.

On the thermodynamic side an internal heat exchanger between the suction and liquid line is recommended as this will improve the refrigeration capacity and COP.

Due to the particularly good solubility with mineral oils, it may be necessary to use an oil with lower mixing characteristics or increased viscosity for higher suction pressures (air-conditioning range).

In connection to this, an internal heat exchanger is also an advantage as it leads to higher oil temperatures thus to lower solubility with the result of an improved viscosity.

Due to the very favourable temperature behaviour (Fig. 25), single stage compressors can be used down to approximately -40°C evaporation temperature. R290 could then also be considered as a direct substitute for R502 or an alternative for some of the HFC blends.

On demand a palette of semi-hermetic reciprocating compressors is available for R290. Due to the individual requirements a specifically equipped compressor is offered. Extension "P" with compressor designation – e.g. 4CC-9.2P. Inquires and orders need a distinctive indication to R290. The handling of the order does include an individual agreement between the contract partners. Open reciprocating compressors are also available for R290, together with a comprehensive program of flame-proof accessories which may be required.

Conversion of existing CFC plants

Due to the flame-proof protection measures required for an R290 plant, it would appear that a conversion of existing plants is only possible in exceptional cases.

They are limited to systems, which can be modified to meet the corresponding safety regulations with an acceptable effort.

Supplementary BITZER information concerning the use of R290

- Technical Information KT-660 "Application of Propane with semi-hermetic reciprocating compressors"

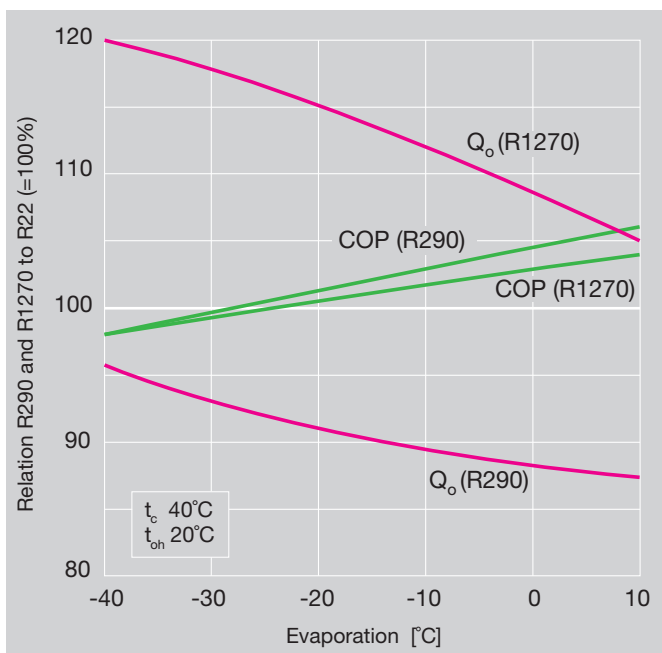

Fig. 27 R290/R1270/R22 – comparison of performance data of a semi-hermetic compressor

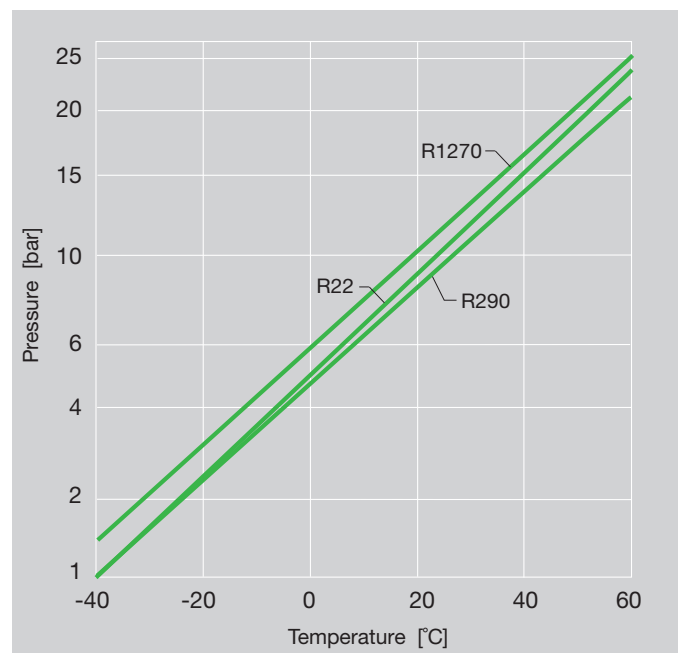

Fig. 28 R290/R1270/R22 – comparison of pressure levels

Propylene (R1270) as an alternative to Propane

For some time there has also been increasing interest in using propylene (propene) as a substitute for R22/R502. Due to its higher volumetric refrigeration capacity and lower boiling temperature (compared to R290) applications in medium and low temperature systems, e.g. liquid chillers for supermarkets, are of particular interest. On the other hand, higher pressure levels (>20%) and discharge gas temperatures have to be taken into consideration, thus restricting the possible application range.

Material compatibility is comparable with propane, as is the choice of lubricants.

Propylene is also easily inflammable and belongs to the A3 group of refrigerants. The same safety regulations are therefore to be observed as with propane (page 25).

Due to the chemical double linkage propylene is relatively reaction friendly, which means that there is a danger of polymerization at high pressure and temperature

levels. Tests carried out by hydrocarbon manufacturers and stability tests in real applications show that reactivity in refrigeration systems is practically non-existent. Doubts have occasionally been mentioned in some literature regarding propylene's possible carcinogenic effects. These assumptions have been disproved by appropriate studies.

Resulting design criteria

With regard to system technology, experience gained from the use of propane can widely be applied to propylene. However, component dimensions have to be altered due to higher volumetric refrigeration capacity (Fig. 27). The compressor displacement is correspondingly lower and therefore also the suction and high pressure volume flows. Because of higher vapour density the mass flow is almost the same as for R290. As liquid density is nearly identical the same applies for the liquid volume in circulation.

As with R290 the use of an internal heat exchanger between suction and liquid lines is of advantage. However, due to R1270's higher discharge gas temperature restrictions are partly necessary.

BITZER has carried out a series of investigations with R1270. In addition there are experiences with the operation in real plants. An individual compressor selection is possible upon demand.

Carbon Dioxide R744 (CO₂) as an alternative refrigerant and secondary fluid

CO₂ has had a long tradition in the refrigeration technology reaching far into the 19th century. It has no ozone depleting potential, a negligible direct global warming potential (GWP = 1), is chemically inactive, non-flammable and not toxic in the classical sense. That is why CO₂ is not subjected to the stringent demands regarding containment as apply for HFCs (F-Gas Regulation), and flammable or toxic refrigerants. However, compared to HFCs the lower practical limit in air has to be considered. For closed rooms this may require special safety and detection systems.

CO₂ is also low in cost and there is no necessity for recovery and disposal. In addition, it has a very high volumetric refrigeration capacity, which depending on operating conditions equates to approx. 5 – 8 times more than R22 and NH₃.

Above all, the safety relevant characteristics were an essential reason for the initial widespread use. The main focus for appli-

cations were marine refrigeration systems, for example. With the introduction of the “Safety Refrigerants”, CO₂ became less popular and since the fifties had nearly disappeared.

The main reasons for that are its relatively unfavourable thermodynamic characteristics for usual applications in refrigeration and air-conditioning. The discharge pressure with CO₂ is extremely high and the critical temperature at 31°C (74 bar) is very low. Depending on the heat source temperature at the high pressure side transcritical operations with pressures beyond 100 bar are required. Under these conditions, the energy efficiency is often lower compared to the classic vapour compression process (with condensation), and therefore the indirect global warming effect is suitably higher.

Nonetheless, there is a range of applications in which CO₂ can be used very economically and with favourable Eco-Efficiency. For example, these include subcritically operated cascade plants, but also transcritical systems, in which the temperature glide on the highpressure side can be used advantageously, or the system conditions permit subcritical oper-

ation for long periods. In this connection it must also be noted that the heat transfer coefficients of CO₂ are considerably higher than of other refrigerants – with the potential of very low temperature differences in evaporators, condensers, and gas coolers. Moreover, the necessary pipe dimensions are very small, and the influence of the pressure drop is comparably low. In addition, when used as a secondary fluid, the energy demand for circulation pumps is extremely low.

In the following section, a few examples of subcritical systems and the resulting design criteria are described. An additional section provides details on transcritical applications.

Subcritical applications

From energy and pressure level points of view, very beneficial applications can be seen for industrial and larger commercial refrigeration plants. For this, CO₂ can be used as a secondary fluid in a cascade system and if required, in combination with a further booster stage for lower evaporating temperatures (Fig. 30/1). The operating conditions are always subcritical which guarantees good efficiency

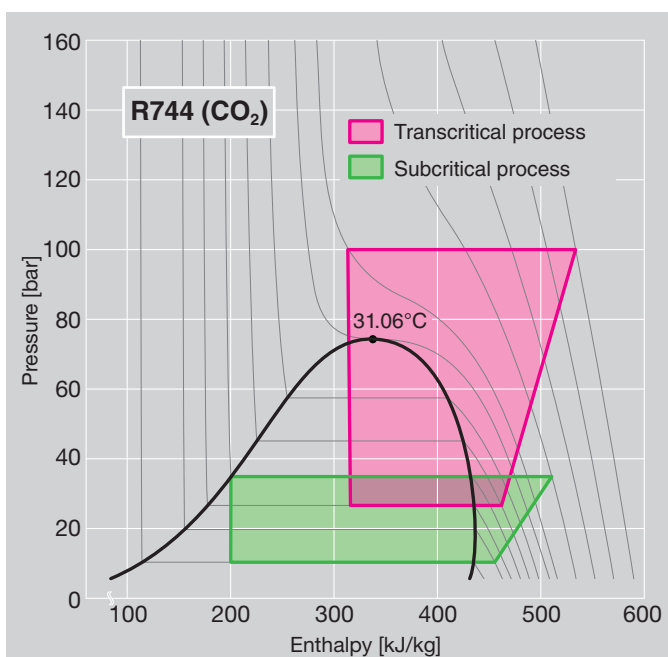

Fig. 29/1 R744(CO₂) – Pressure-/Enthalpy-Diagram

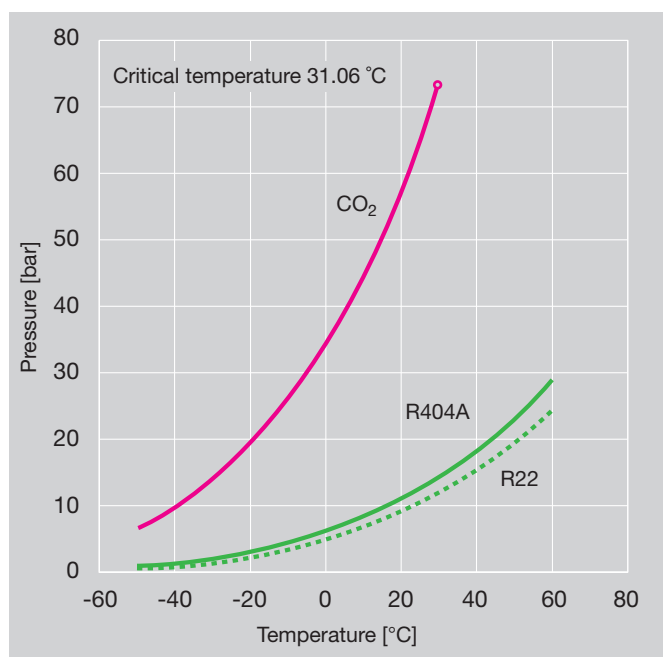

Fig. 29/2 R744(CO₂)/R22/R404A – comparison of pressure levels

levels. In the most favourable application range (approx. -10 to -50°C), pressures are still on a level where already existing components or items in development, e.g. for R410A, can be matched with acceptable effort.

Resulting design criteria

For the high temperature side of such a cascade system, a compact cooling unit can be used, whose evaporator serves on the secondary side as the condenser for CO₂. Chlorine-free refrigerants (NH₃, HCs or HFCs) are suitable.

With NH₃ the cascade heat exchanger should be designed so that the dreaded build-up of ammonium carbonate is prevented in the case of leakage. This technology has been applied in breweries for a long time.

A secondary circuit for larger plants with CO₂ could be constructed utilising, to a wide extent, the same principles for a low pressure pump circulating system, as is often used with NH₃ plants. The essential difference exists therein, that the condensing of the CO₂ results in the cascade cooler, and the receiver tank (accumulator) only serves as a supply vessel.

The extremely high volumetric refrigeration capacity of CO₂ (latent heat through the changing of phases) leads to very low mass flow rates and makes it possible to use small cross sectional pipe and minimal energy needs for the circulating pumps.

For the combination with a further compression stage, e.g. for low temperatures, there are different solutions.

Fig. 30/1 shows a variation with an additional receiver where one or more Booster compressors will pull down to the necessary evaporation pressure. Likewise, the discharge gas is fed into the cascade cooler, condenses and then carried over to the receiver (MT). The feeding of the low pressure receiver (LT) is achieved by a level control device.

Instead of classical pump circulation the booster stage can also be built as a so-called LPR system.

The circulation pump is thus not necessary but the number of evaporators is then limited with a view to an even distribution of the injected CO₂.

In the case of a system breakdown where a high rise in pressure could occur, safety valves can vent the CO₂ to the atmosphere with the necessary precautions.

As an alternative to this, additional cooling units for CO₂ condensation are also used where longer shut-off periods can be bridged without a critical pressure increase.

For systems in commercial applications a direct expansion version is possible as well.

Supermarket plants with their usually widely branched pipe work offer an especially good potential in this regard. The medium temperature system is then carried out in a conventional design or with a secondary circuit and for low temperature application combined with a CO₂ cascade system (for subcritical operation). A system example is shown in Fig. 30/2.

For a general application, however, not all requirements can be met at the moment. It is worth considering that system technology changes in many respects and specially adjusted components are necessary to meet the demands.

The compressors, for example, must be properly designed because of the high vapour density and pressure levels (particularly on the suction side). There are also specific requirements with regard to materials. Furthermore only highly dehydrated CO₂ must be used.

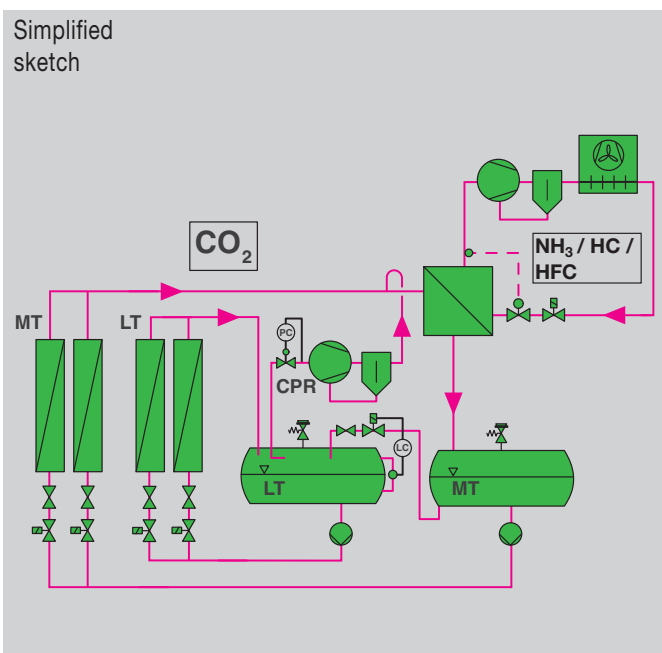

Fig. 30/1 Cascade system with CO₂ for industrial applications

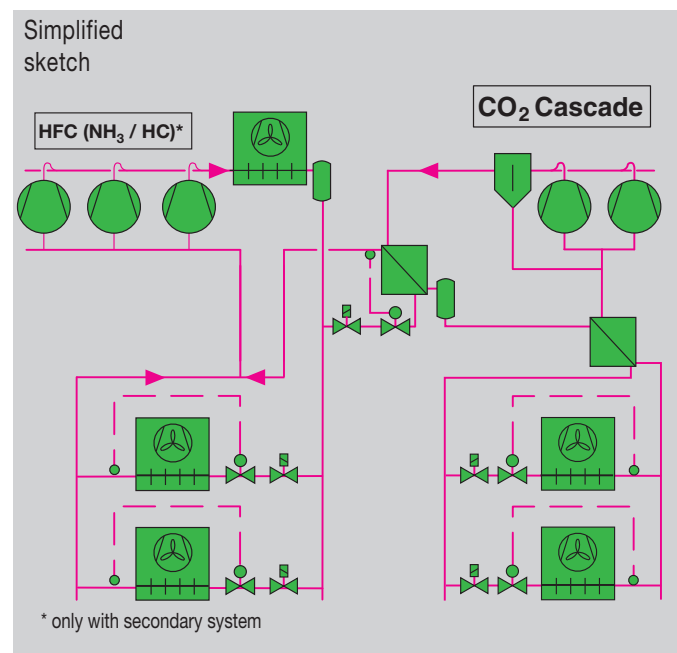

Fig. 30/2 Conventional refrigeration system combined with CO₂ low temperature cascade

High demands are made on lubricants as well. Conventional oils are mostly not miscible and therefore require costly measures to return the oil from the system. On the other hand, a strong viscosity reduction with the use of a miscible and highly soluble POE must be considered.

Further development work is necessary, also with regard to the adaptation of technical standards and safety requirements.

For subcritical CO₂ applications BITZER already offers a wide range of special compressors.

Supplementary BITZER information concerning compressor selection for subcritical CO₂ systems

- ❑ Brochure KP-120
CO₂ Compressors for subcritical applications
- ❑ Additional publications on request

Transcritical applications

Transcritical processes are characterized in that the heat rejection on the high-pressure side proceeds isobar but not isotherm. Contrary to the condensation process during subcritical operation, gas cooling (de-superheating) occurs, with corresponding temperature glide. Therefore, the heat exchanger is described as gas cooler. As long as operation remains above the critical pressure (74 bar), only high-density vapour will be transported. Condensation only takes place after expansion to a lower pressure level – e.g. by interstage expansion in an intermediate pressure receiver. Depending on the temperature curve of the heat sink, a system designed for trans-critical operation can

also be operated subcritically, whereby the efficiency is better under these conditions. In this case, the gas cooler becomes the condenser.

Another feature of transcritical operation is the necessary regulation of the high pressure to a defined level. This “optimum pressure” is determined as a function of gas cooler outlet temperature by means of balancing between the highest possible enthalpy difference and simultaneous minimum compression work. It must be adapted to the relevant operating conditions using an intelligent modulating controller (see system example, Fig. 31).

As described above, under purely thermodynamic aspects, the transcritical operating mode appears to be unfavourable in terms of energy efficiency. In fact, this is true for systems with a relatively high temperature level of the heat sink on the highpressure side. However, additional measures can be taken for improving efficiency, such as the use of expanders, ejectors, and economiser systems. Apart from that, there are application areas in which a transcritical process is energetically advantageous. These include heat pumps for sanitary water, or drying processes. With the usually very high temperature gradients between the discharge temperature at the gas cooler intake and the heat sink intake temperature, a very low outlet gas temperature is achievable. This is positively influenced by the temperature glide curve and the relatively high mean temperature difference between CO₂ vapour and secondary fluid. The low gas outlet temperature leads to a particularly high enthalpy difference, and therefore to a high system COP.

Low-capacity sanitary water heat pumps are already manufactured and used in large quantities. Plants for medium to higher capacities (e.g. hotels, indoor swimming pools) are still in the development and introductory phase.

Apart from these specific applications, there is also a range of developments for the classical areas of refrigeration and air-conditioning. This also covers supermarket refrigeration plants, for example. Meanwhile, and following extensive laboratory tests, real installations with parallel compound compressors are in operation. The operating experience and the determined energy costs show promising results. However, the investment costs are still considerably higher than for classical plants with HFCs and direct expansion.

On the one hand, the reasons for the favourable energy costs lie in the high degree of optimized components and the system control, and also in the previously described advantages regarding heat transfer and pressure drop. On the other hand, these installations are mostly used in climate areas permitting very high running times in subcritical operation due to the annual ambient temperature profile.

Insofar, but also in view of the very demanding technology and the high requirements placed on the qualification of planners and service personnel, CO₂ technology cannot be regarded as a general replacement for plants using HFC refrigerants.

Resulting design criteria

Detailed information on this topic would go beyond the scope of this publication. In any case, the system and control techniques are substantially different from conventional plants. Already when considering pressure levels as well as volume and mass flow ratios specially developed components, controls, and safety devices as well as suitably dimensioned pipework must be provided.

The compressor technology is particularly demanding. The special requirements result in a completely independent approach. For example, this involves design,

materials (bursting resistance), displacement, crank gear, working valves, lubrication system, as well as compressor and motor cooling. Hereby, the high thermal load severely limits the application for single-stage compression. Low temperature cooling requires 2-stage operation, whereby separate high and low pressure compressors are particularly advantageous with parallel compounded systems.

The criteria mentioned above in connection with subcritical systems apply to an even higher degree for lubricants.

Further development is necessary in many areas, and for most applications, transcritical CO₂ technology cannot yet be regarded as state-of-the-art.

For transcritical CO₂ applications, BITZER already offers a wide range of special compressors.

Their use is aimed at specific applications, therefore individual examination and assessment are required.

Supplementary BITZER information concerning compressor selection for transcritical CO₂-systems

- ❑ Brochure KP-130
CO₂ compressors for transcritical applications
- ❑ Additional publications upon request

CO₂ in mobile air-conditioning systems

Within the scope of the long-discussed measures for reducing direct refrigerant emissions, and the pending ban on the use of R134a in MAC systems*, the development of CO₂ systems has been pursued intensively since several years.

At the first glance, efficiency and therefore the indirect emissions from CO₂ systems under typical ambient conditions appear to be relatively unfavourable. But it must be considered that present R134a systems are less efficient than stationary

plants of the same capacity. The reasons for this lie in the specific installation conditions and the relatively high pressure losses in pipework and heat exchangers. With CO₂, pressure losses have significantly less influence. Moreover, system efficiency is further improved by the high heat transfer coefficients in the heat exchangers.

This is why optimized CO₂ air-conditioning systems are able to achieve efficiencies that are comparable to those of R134a. Regarding the usual leakage rates of such systems, a more favourable balance is obtained in terms of TEWI.

From today's viewpoint, it is not yet possible to make a prediction as to whether the CO₂ technology can become established in this application in short or medium term. Certainly, this also depends on experiences with "Low GWP" refrigerants (page 11). Hereby, other aspects such as operating safety, costs, and global logistics will play an important role.

* See page 11 for further information.

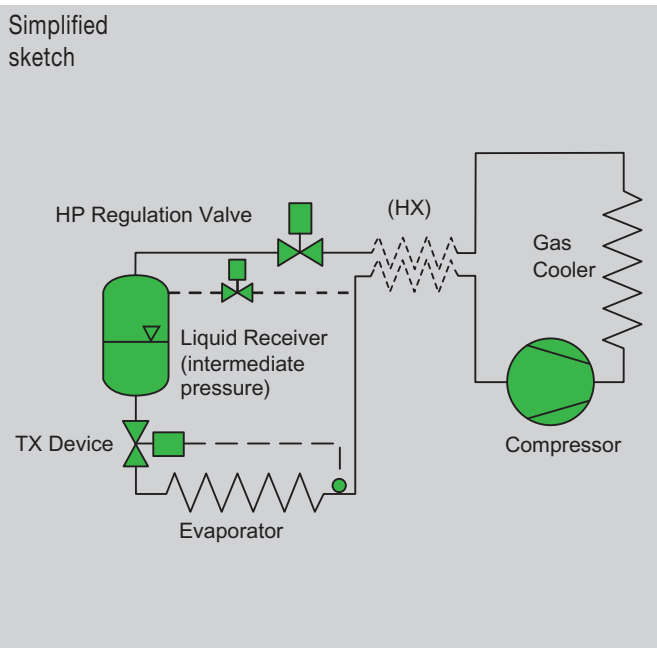

Fig. 31 Example of a transcritical CO₂ system

R124 and R142b as substitutes for R114 and R12B1

Instead of the refrigerants R114 and R12B1 predominately found in the past in high temperature heat pumps and crane cabin A/C installations, the HCFC R124 and R142b can be used as alternatives in new installations.

With these gases it is also possible to use long proven lubricants, preferably mineral oils and alkyl benzenes with high viscosity.

Because of the Ozone Depleting Potential, the use of these refrigerants must certainly only be regarded as an interim solution (in the EU member states, the application in new systems is no longer allowed). The flammability of R142b should also be considered with the resulting safety implications (refrigerant group A2).

Resulting design criteria/ Converting existing plants

In comparison to R114 the boiling temperatures of the alternatives are lower (approx. -10°C) which results in larger differences in the pressure levels and refrigeration volumetric capacities. This leads to stronger limitations in the application range concerning high evaporation and condensing temperatures.

A conversion of an existing installation will in most cases necessitate the exchanging of the compressor and regulating devices. Owing to the lower volume flow (higher volumetric refrigeration capacity), possible adjustments to the evaporator and the suction line will be required.

Over the previous years BITZER compressors have been found to be well suited with R124 and R142b in actual installations. Depending on performance data and compressor type modifications are necessary, however. Performance data including further design instructions are available on request.

Chlorine free substitutes for special applications

Due to the limited markets for systems with extra high and low temperature applications, the requirements for the development of alternative refrigerants and system components for these areas has not been so great.

In the meantime a group of alternatives for the CFC R114 and Halon R12B1 (high temperature), R13B1, R13 and R503 (extra low temperature) were offered as the replacements. With closer observations it has been found that the thermodynamic properties of the alternatives differ considerably from the substances used until now. This can cause costly changes especially with the conversion of existing systems.

Alternatives for R114 and R12B1

At present R227ea and R236fa are regarded as the preferred substitutes. R227ea cannot be seen as a full replacement. Recent research and field tests have shown favourable results, but with normal system technology the critical temperature of 102°C limits the condensing temperatures to about $85..90^{\circ}\text{C}$.

R236fa provides the more favourable conditions at least in this regard – the critical temperature is above 120°C . A disadvantage, however, is the smaller volumetric refrigeration capacity. This is similar to R114 and with that 40% below the performance of R124 which is widely used for extra high temperature applications today.

In the meantime, an azeotropic blend of R365mfc and a perfluoropolyether has also been developed. It is available under the trade name Solkatherm SES36 (Solvay). Its boiling temperature (at 1.013 bar) is 36.7°C , and the critical temperature is 177.4°C . The preferred application areas will therefore be heat pumps in process technology, and Organic Rankine Cycles (ORC).

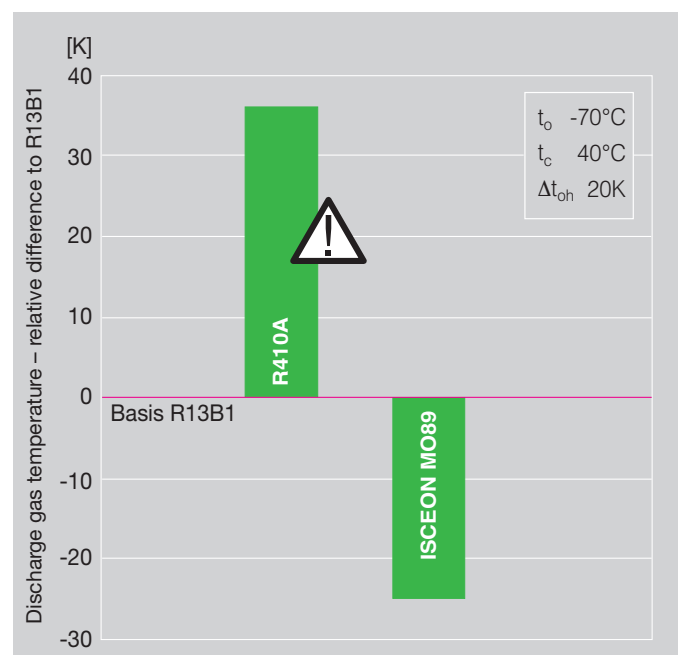

Fig. 32 R13B1/HFC alternatives – comparison of discharge gas temperatures of a 2-stage compressor

Refrigerant R600a (Isobutane) will be an interesting alternative where the safety regulations allow the use of hydrocarbons (Group A3). With a critical temperature of 135°C, condensing temperatures of 100°C and more are within reach.

The volumetric refrigeration capacity is almost identical to R124.

The "Low GWP" refrigerant HFO-1234ze can also be regarded as a potential candidate for extra high temperature applications. Compared to R124, its cooling capacity is higher by 10 to 20% and its pressure level by about 25%. At an identical cooling capacity, the mass flow differs only slightly. Its critical temperature is 107°C, which would enable an economical operation up to a condensing temperature of about 90°C. However, like HFO-1234yf, HFO-1234ze is mildly flammable and will therefore probably be classified in the new safety group A2L. The corresponding safety regulations must be observed.

However, until now no sufficient operating experience is available, which is why an assessment of the suitability of this refrigerant for long-term use is not yet possible.

Alternatives for R13B1

Besides R410A, ISCEON MO89 (DuPont) can be regarded as potential R13B1 substitute. With R410A a substantially higher discharge gas temperature is to be considered when compared to R13B1 which restricts the application range even in 2-stage compression systems to a greater extent.

ISCEON MO89 is a mixture of R125 and R218 with a small proportion of R290. Due to the properties of the two main components, density and mass flow are relatively high and discharge gas temper-

ature is very low. Liquid subcooling is of particular advantage.

Both of the mentioned refrigerants have relatively high pressure levels and are therefore limited to 40 through 45°C condensing temperature. They also show less capacity than R13B1 at evaporating temperatures below -60°C.

In addition to this, the steep fall of pressure limits the application at very low temperatures and may require a change to a cascade system with for example R23 in the low temperature stage.

Lubrication and material compatibility are assessed as being similar to the other HFC blends.

Alternatives for R13 and R503

The situation is more favourable with these substances as R23 and R508A/R508B can already replace R13 and R503. Refrigerant R170 (Ethane) is also suitable when the safety regulations allow the use of hydrocarbons (Group A3).

Due to the partly steeper pressure curve of the alternative refrigerants and the higher discharge gas temperature of R23 compared with R13, differences in performance and application ranges for the compressors must be considered. Individual adaptation of the heat exchangers and controls is also necessary.

As lubricants for R23 and R508A/B, polyol ester oils are suitable, but these must be matched for the special requirements at extreme low temperatures.

R170 has also good solubility with conventional oils, however an adaptation to the temperature conditions will be necessary.

BITZER has already carried out investigations and also collected experiences with several of the substitutes mentioned, performance data and instructions are available on request.

Due to the individual system technology for these special installations, consultation with BITZER is necessary.



Refrigerant type	Composition (Formula)	Substitute for	Application range	ODP [R11=1.0]	GWP _(100a) ^{⑤⑥} [CO ₂ =1.0]	Safety group ^④	Practical limit [kg/m ³] ^⑤
HCFC-Refrigerants							
R22	CHClF ₂	R502 (R12 ^①)	see page 38	0.055	1700	A1	0.3
R124	CHClFCF ₃	R114 ^① , R12B1		0.022	620	A1	0.11
R142b	CClF ₂ CH ₃			0.065	2400	A1	0.066
HFCFC/HFC Service-Blends (Transitional Alternatives)							
R401A	R22/152a/124	R12 (R500)	see page 38	0.037	1130	A1	0.3
R401B	R22/152a/124			0.04	1220	A1	0.34
R409A	R22/142b/124			0.048	1540	A1	0.16
R402A	R22/125/290	R502	see page 38	0.021	2690	A1	0.33
R402B	R22/125/290			0.033	2310	A1	0.32
R403B	R22/218/290			0.031	4310	A1	0.41
R408A	R22/143a/125			0.026	3020	A1	0.41
HFC – chlorine free – Refrigerants (Long Term Alternatives)							
R134a	CF ₃ CH ₂ F	R12 (R22 ^①) mainly used as part components for blends	see page 38	0	1300	A1	0.25
R152a	CHF ₂ CH ₃				120	A2	0.027
R125	CF ₃ CHF ₂				3400	A1	0.59
R143a	CF ₃ CH ₃				4300	A2	0.056
R32	CH ₂ F ₂				550	A2	0.061
R227ea	CF ₃ -CHF-CF ₃	R12B1, R114 ^① R114	see page 38	0	3500	A1	0.59
R236fa	CF ₃ -CH ₂ -CF ₃				9400	A1	0.59
R23	CHF ₃	R13 (R503)			12000	A1	0.68
HFC – chlorine free – Blends (Long Term Alternatives)							
R404A	R143a/125/134a	R22 (R502)	see page 38	0	3780	A1	0.52
R507A	R143a/125				3850	A1	0.53
R407A	R32/125/134a				1990	A1	0.33
R407F	R32/125/134a				1705	A1	0.29
R422A	R125/134a/600a				3040	A1	0.29
R437A	R125/134a/600/601	R12 (R500)			1680	A1	0.08
R407C	R32/125/134a	R22	see page 38	0	1650	A1	0.31
R417A	R125/134a/600				2240	A1	0.15
R417B	R125/134a/600				2920	A1	0.07
R422D	R125/134a/600a				2620	A1	0.26
R427A	R32/125/143a/134a				2010	A1	0.28
R438A	R32/125/134a/600/601a				2150	A1	0.08
R410A	R32/125	R22 ^① (R13B1 ^②)			1980	A1	0.44
ISCEON M089	R125/218/290	R13B1 ^②			N/A	N/A	N/A
R508A	R23/116	R503	see page 38	0	11940	A1	0.23
R508B	R23/116				11950	A1	0.2
Halogen free Refrigerants (Long Term Alternatives)							
R717	NH ₃	R22 (R502)	see page 39	0	0	B2	0.00035
R723	NH ₃ /R-E170	R22 (502)			8	B2	N/A
R600a	C ₄ H ₁₀	R114, R12B1			3	A3	0.011
R290	C ₃ H ₈	R22 (R502)			3	A3	0.008
R1270	C ₃ H ₆	R22 (R502)			3	A3	0.008
R170 ^③	C ₂ H ₆	R13, R503			3	A3	0.008
R744	CO ₂	Diverse			1	A1	0.07

Fig. 33 Characteristics of CFC alternatives (continued on Fig. 34)

These statements are valid subject to reservations; they are based on information published by various refrigerant manufacturers.

① Alternative refrigerant has larger deviation in refrigerating capacity and pressure

③ Also proposed as a component in R290/600a-Blends (direct alternative to R12)

⑥ Time horizon 100 years – according to IPCC III (2001) → reference data in EN 378-1: 2008, Annex E – also basis for EC Regulation 842/2006

② Alternative refrigerant has larger deviation below -60°C evaporating temperature

④ Classification according to EN378-1 and ASHRAE 34

⑤ According to EN 378-1, Annex E

N/A Data not yet available.

Refrigerant type	Boiling temperature [°C] ①	Temperature glide [K] ②	Critical temperature [°C] ①	Cond. temp. at 26 bar (abs) [°C] ①	Refr. capacity [%] ③	Discharge gas temp. [K] ③	Lubricant (compressor)	
HCFC-Refrigerants								
R22	-41	0	96	63	80 (L) ④	+35 ④	see page 39	
R124	-11	0	122	105	⑤	⑤		
R142b	-10	0	137	110	⑤	⑤		
HCFC/HFC Service-Blends (Transitional Alternatives)								
R401A	-33	6.4	108	80	107 (M)	+13		
R401B	-35	6.0	106	77	108 (L)	+18		
R409A	-34	8.1	107	75	109 (M)	+7		
R402A	-49	2.0	75	53	109 (L)	~0		
R402B	-47	2.3	83	56	99 (L)	+16		
R403B	-51	1.2	90	54	112 (L)	~0		
R408A	-44	0.6	83	58	98 (L)	+10		
HFC – chlorine free – Refrigerants (Long Term Alternatives)								
R134a	-26	0	101	80	97 (M)	-8		
R152a	-24	0	113	85	N/A	N/A		
R125	-48	0	66	51	N/A	N/A		
R143a	-48	0	73	56	N/A	N/A		
R32	-52	0	78	42	N/A	N/A		
R227ea	-16	0	102	96	⑤	⑤		
R236fa	-1	0	>120	117	⑤	⑤		
R23	-82	0	26	1	⑤	⑤		
HFC – chlorine free – Blends (Long Term Alternatives)								
R404A	-47	0.7	73	55	105 (M)	-34		
R507A	-47	0	71	54	107 (M)	-34		
R407A	-46	6.6	83	56	98 (M)	-19		
R407F	-46	6.4	83	57	104 (M)	-11		
R422A	-49	2.5	72	56	100 (M)	-39		
R437A	-33	3.6	95	75	108 (M)	-7		
R407C	-44	7.4	87	58	100 (H)	-8		
R417A	-39	5.6	87	68	97 (H)	-25		
R417B	-45	3.4	75	58	95 (M)	-37		
R422D	-45	4.5	81	62	90 (M)	-36		
R427A	-43	7.1	87	64	90 (M)	-20		
R438A	-42	6.6	80	63	88 (M)	-27		
R410A	-51	<0.2	72	43	140 (H)	-4		
ISCEON M089	-55	4.0	70	50	⑤	⑤		
R508A	-86	0	13	-3	⑤	⑤		
R508B	-88	0	14	-3	⑤	⑤		
Halogen free Refrigerants (Long Term Alternatives)								
R717	-33	0	133	60	100 (M)	+60		
R723 ③	-37	0	131	58	105 (M)	+35		
R600a	-12	0	135	114	N/A	N/A		
R290	-42	0	97	70	89 (M)	-25		
R1270	-48	0	92	61	112 (M)	-20		
R170	-89 ⑥	0	32	3	⑤	⑤		
R744	-57	0	31	-11	⑤	⑤		

Fig. 34 Characteristics of CFC alternatives

① Rounded values

② Total glide from bubble to dew line – based on 1 bar (abs.) pressure. Real glide dependent on operating conditions. Approx. values in evaporator: H/M 70%; L 60% of total glide

③ Reference refrigerant for these values is stated in Fig. 33 under the nomination “Substitute for” (column 3) Letter within brackets indicates operating conditions
 H High temp (+5/50°C)
 M Medium temp (-10/45°C)
 L Low temp (-35/40°C)

④ Valid for single stage compressors

⑤ Data on request (operating conditions must be given)

⑥ Triple point at 5,27 bar

Stated performance data are average values based on calorimeter tests.

Transitional/Service refrigerants

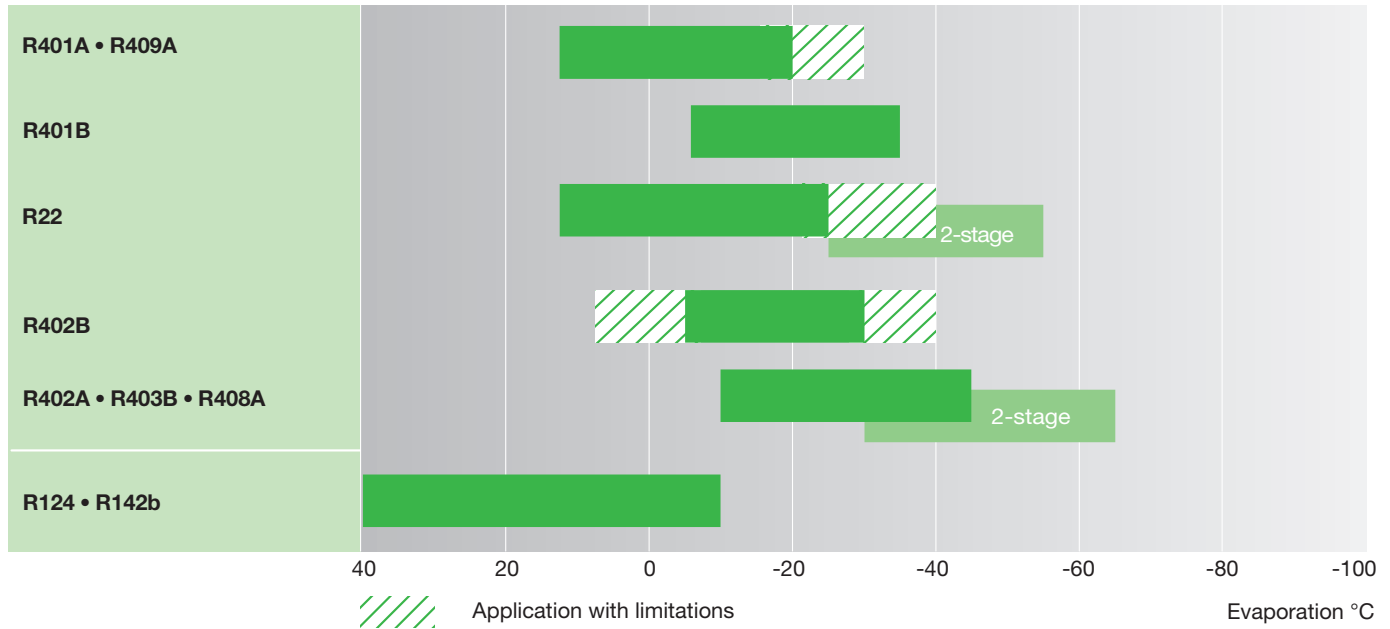

Fig. 35 Application ranges for HCFC's and Service Blends

Chlorine free HFC refrigerants and blends

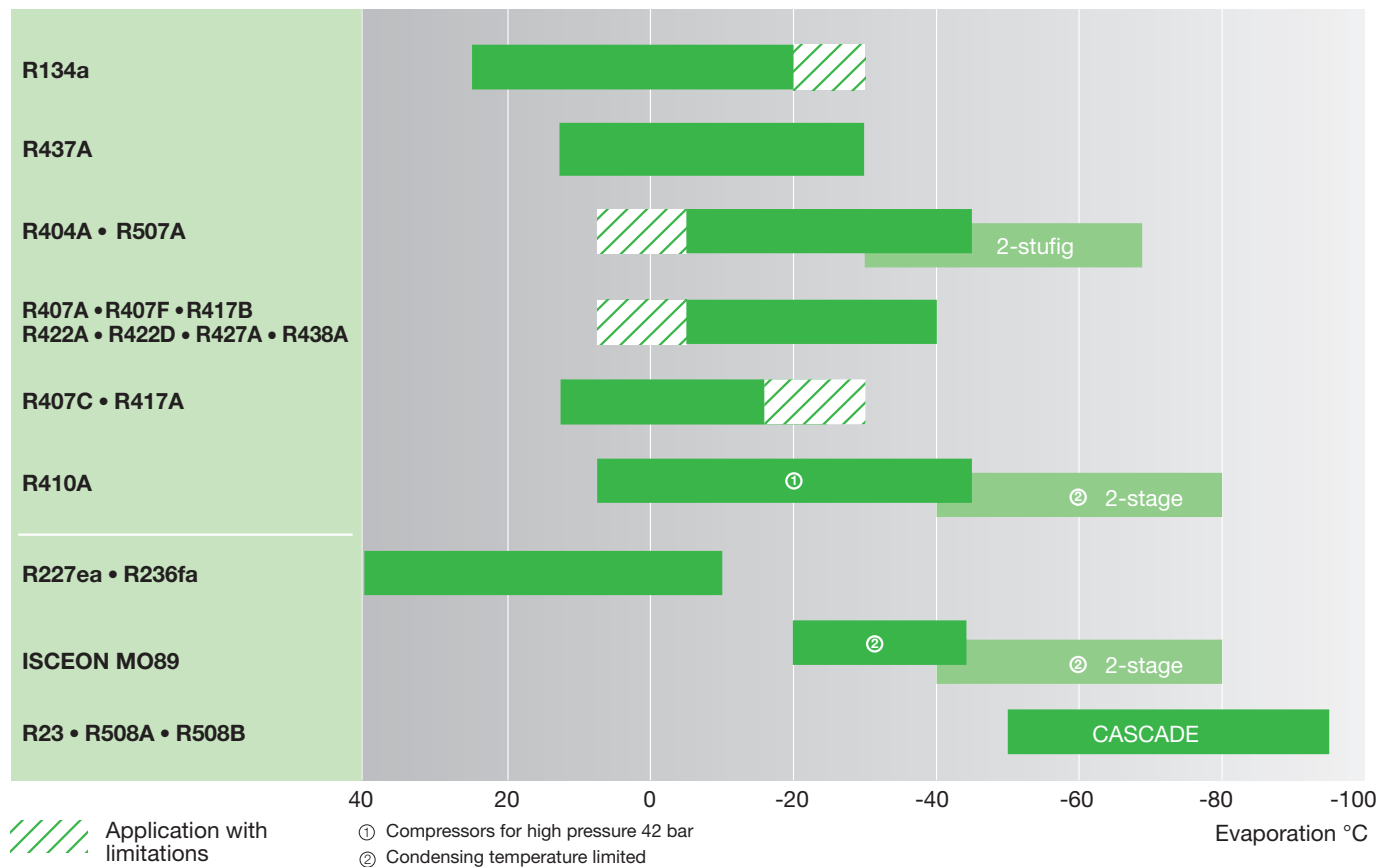

Fig. 36 Application ranges for HFC refrigerants and blends (ODP = 0)

Halogen free refrigerants

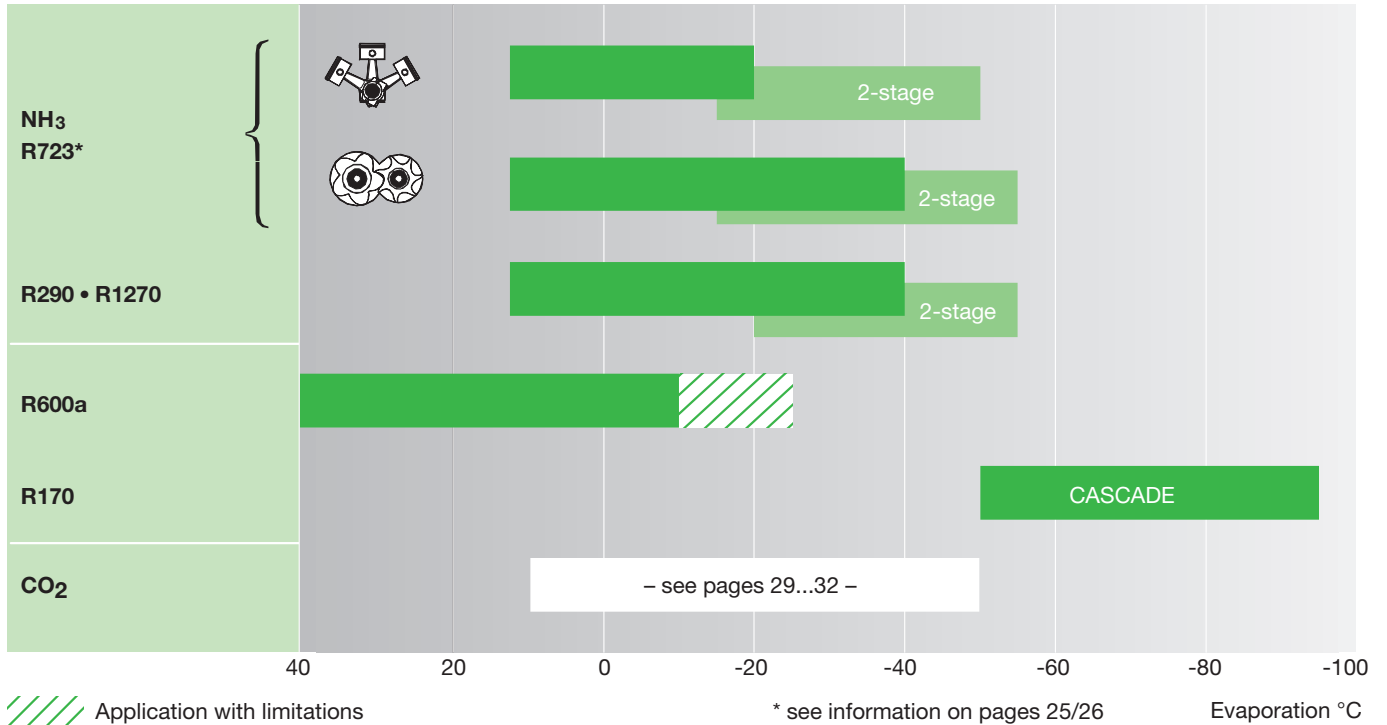

Fig. 37 Application ranges for halogen free refrigerants

Lubricants

	Traditional oils				New lubricants			
	Mineral oil (MO)	Alkyl-benzene (AB)	Mineral oil + alkyl-benzene	Poly-alpha-olefin (PAO)	Polyol ester (POE)	Polyvinyl-ether (PVE)	Poly-glycol (PAG)	Hydro cracked mineral oil
(H)CFC	Good	Good	Good	Limitations	Warning +VG	Not suitable	Not suitable	Not suitable
Service blends with R22	Limitations	Good	Good	Not suitable	Warning +VG	Not suitable	Not suitable	Not suitable
HFC + blends	Not suitable	Limitations	Not suitable	Not suitable	Good	Good	Warning	Not suitable
HFC/HC blends	Limitations	Limitations	Limitations	Not suitable	Good	Good	Not suitable	Not suitable
Hydrocarbons	VG	VG	VG	VG	VG	Not suitable	Warning	Not suitable
NH ₃ • R723	Good	Limitations	Limitations	Good	Not suitable	Not suitable	Warning	Good

Good suitability
 Application with limitations
 Suitability dependant on system design
 Not suitable
⚠ Especially critical with moisture
 VG Possible higher basic viscosity

Further information see pages 10/11 and explanations for the particular refrigerants.

Fig. 38 Lubricants for compressors



BITZER Kühlmaschinenbau GmbH
Eschenbrünlestraße 15 // 71065 Sindelfingen // Germany
Tel +49 (0)70 31 932-0 // Fax +49 (0)70 31 932-147
bitzer@bitzer.de // www.bitzer.de

Subject to change // 09.2010